

HARDINGE WORKHOLDING

Spindle Tooling for Manual & CNC Lathes



800-843-8801
WWW.HARDINGE.COM



Value in Workholding

Team up with Hardinge to add value to your material-cutting processes and assembly operations. Work with dedicated sales, design and application engineers to solve difficult process problems, or choose your standard collet or step chuck knowing that quality and reliability comes with the Hardinge name. Experience value in longer lasting products, value in machine uptime, value in work-piece accuracy and value in your customer's satisfaction.



From bar stock to finished product – *100% Made in USA*

Individual care goes into every collet, feed finger and pad, at each manufacturing process, from handling the initial bar stock to polishing and laser etching. Generations of skilled-machine operators have taken part in the many critical processes of producing a hardened, precision-machined collet. Hardinge has been manufacturing workholding and industrial products for all brands of lathes, mills and grinding machines for over a century. Their process expertise, precision and accuracy provides a workholding product that is world-renowned.

Hardness, Spring and Spread

A very important factor in manufacturing collets, feed fingers and pads that are long lasting and provide the performance you expect is the raw material used and the heat treat process control system to guarantee proper hardness and tempering. Collets and feed fingers are prone to breakage where the hardened area meets the tempered area. Hardinge heat treat processes are planned to eliminate breakage on critical design areas to provide a product that is not subject to breakage and wear. Hardinge collets are 5 to 7 points of Rockwell "C" harder than competitor's products to provide a longer lasting product. The harder the collet, the longer the life, reducing collet changeover and downtime associated with collet changing. However, if a collet is too hard, it could be brittle and break. It is the combination of hardness, spring and spread that Hardinge has perfected over the years at their Elmira, New York facility.

Collet Concentricity Inspection

Concentricity is measured in terms of Total Indicator Runout (TIR) using a Hardinge Super-Precision® spindle. A gage pin is inserted in the collet and the TIR is measured at a set distance from the spindle face, depending on the order hole size, using a .00005" dial indicator. You can be assured of a qualified inspection – standard 5C collets will run .001" or better, while special accuracy collets will run .0002" or better. This assures that the collet will hold your part consistently during your specified machining operations.

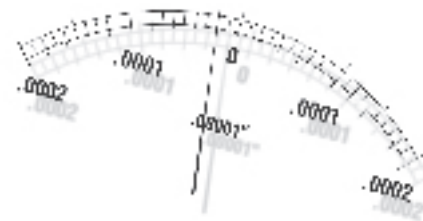

Hardened, Precision-Machined Collets	4, 5, 7
5C, 16C, 20C, 25C & 3J Collets and Collet Sets	
Collet Sets	
Step Collets	
Extended-Nose Collets	
Headstock Centers (Male Center)	
Lensmaker Collets	
Long Bearing Drill Collets	
Emergency Collets	6
5C, 16C, 20C, 25C & 3J	
Extended-Nose	
Kellenberger 5C Collet Adaptation Chuck	7
Step Chucks & Closers	8-12
5C, 16C, 20C, 25C & 3J – Hardened, Precision-Machined and Emergency	
3C & 4C – Hardened, Precision-Machined	
Collet Stops	13-14
Threaded Positive Solid Stops, Long Stops, Ejector Stops	
5C Universal Collet Stop	
16C Universal Draw Tube Stop	
Dead-Length® Collets – 5C & 16C	15
Dead-Length Emergency Step Chucks – 5C, 16C & 20C	16
Dead-Length Thru-Hole Collets - 5C, 16C	17
Dead-Length Collet Ejector Stops – 5C & 16C	18
Dead-Length Spider-Stop Step Chuck – 16C	19
Master Collets & Pads – Style "S" Draw-In	20
S10, S12, S16, S20, S22 & S26	
Expanding Collets	
5C & 16C Master Expanding Collets	21
Model-S Precision Expanding Collets – 5C & 16C	22
Model-S Emergency Expanding Collets.....	23
Sure-Grip® Expanding Collet Systems	23
Spindle Collet & Step Chuck Adapters	24
Collet Face Spanner Wrenches	24
5C & 16C Fixture & Backing Plates	25
5C Face Plates, Angle Plates, Stub/Mill Arbors & Driver	26
5C Collet Racks	27
Custom Application Manufacturing of Special Collets & Step Chucks	27-30
Stationary Collet Systems	
B65	31-33
B42	34-35
#11 & #22 B&S	36-39
2-, 3- & 4-Jaw Manual Chucks	40
Safety Information for 5C Spindle Tooling	40
Collet Directory - by machine manufacturer	41
Collet Directory - by Style (Dimensions and Capacities)	42-45
Frequently Asked Questions	46-47

Hardened, Precision-Machined Collets



The Hardinge Collet is manufactured to exacting standards from special alloy steel. Threads are heat treated and the body is spring tempered to assure accuracy and durability at low cost. A wide range of standard sizes and shapes (and some not so standard) are available for off-the-shelf delivery. 5C decimal collets are available in .001" increments from .015" up to and including 1.0625". All collets are available in fractional sizes of round, hexagon and square to capacity. In addition, many round collets are stocked in metric, decimal, letter and number sizes. Most of the popular sizes of round serrated, taper hole and rectangular collets are available from stock. Many collets include precision internal threads for the Hardinge threaded positive stops.

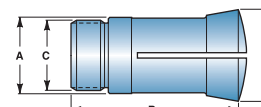

Dimensions and Capacities

Type	A – Back Bearing Diameter	B – Overall Length	C – Thread	D – Head Diameter	●	⬡	■
					Round Capacity	Hex Capacity	Square Capacity
5C	1.250" (31.75)	3.281" (83.34)	1.238" x 20 RH ¹	1.468"	1 1/16" (26.99)	29/32" (23.02)	3/4" (19.05)
16C	1.889" (47.98)	4.312" (109.52)	1.870" x 1.75mm RH ¹	2.265"	1 5/8" (41.28)	1 13/32" (35.72)	1 9/64" (28.97)
20C	2.378" (60.40)	6.250" (158.75)	2.359" (M60x1.5mm RH) ¹	2.880" (73.15)	2" (50.80)	1 3/4" (44.45)	1 27/64" (36.11)
25C	2.930" (74.42)	6.480" (161.59)	2.871" (M73x1.5mm RH) ¹	3.470" (88.14)	2.559" (65.00)	2.216" (56.29)	1.808" (45.92)
3J	2.000" (50.80)	3.750" (95.25)	1.988" x 20 RH	2.205"	1 3/4" (44.45)	1 17/32" (38.89)	1 1/4" (31.75)

1 - Internal Stop Thread: (5C: 1.041" x 24 RH), (16C: 1.687" x 20 TPI RH), (20C: M53 x 1mm RH), (25C : 2 5/8" x 24 TPI RH), (3J : 1.79" x 24 TPI RH).

5C Hardened, Precision-Machined Collets



Description	Part Number	Figure	Size Range
Special Accuracy	1003-00-00-000000	1	1/64" to 1 1/16", Decimal, Metric & Fractional Sizes
Round Fractional	1001-00-19-000000	1	1/64" to 1 1/16" inclusive by 1/64" increments
Hexagon Fractional	1001-00-29-000000	1	1/16" to 7/8" inclusive by 1/64" increments
Square Fractional	1001-00-39-000000	1	3/64" to 3/4" inclusive by 1/64" increments
Round Metric	1001-00-17-000000	1	.5mm to 27mm inclusive by .5mm increments ¹
Round Decimal	1001-00-18-000000	1	.016" to 1.030" inclusive by .001" increments ¹
Round Serrated Fractional	1001-00-59-000000	1	1/4" to 1 1/64" inclusive by 1/64" increments ¹
Morse Taper Hole	1005-08-80-000000	2	#1, #2, #3, #4
B & S Taper Hole	1005-09-80-000000	2	#4, #5, #6, #7, #9
Rectangular	1001-00-49-000000	1	1/8" x 5/32" to 5/8" x 3/4" inclusive

NOTE: Round 5C collets above 63/64", hex collets 55/64" and above, square 5C collets 23/32" and over, 5C number collets and letter collets do not have internal threads. For internal threads, see 5C-SC step collets.

Special-Accuracy 5C Collets are available. When held in a Hardinge Super-Precision® spindle, they are guaranteed to have a maximum TIR of .0002" for 5C round collets, and .0005" for 16C, 20C and 25C round collets over 3/16" (4.76mm) to the collet's capacity measured 1" from the face of the collet.



16C, 20C, 25C, 3J Hardened, Precision-Machined Collets

Type	16C Part No. / Size Range		20C Part No. / Size Range		25C Part No. / Size Range		3J Part No. / Size Range	
Round Fractional	1717-00-19	1/16" – 1 1/16" [1/64"]	1701-00-19	1/16" – 2" [1/32"]	1801-00-19	1/4" – 2 5/8" [1/64"]	1593-00-19	1/64" – 1 3/4" [1/64"]
Hexagon Fractional	1717-00-29	1/8" – 1 3/8" [1/16"]	1701-00-29	1/4" – 1 3/4" [1/16"]	1801-00-29	1/2" – 2 1/8" [1/16"]	1593-00-29	3/16" – 1 1/2" [1/16"]
Square Fractional	1717-00-39	1/8" – 1 3/16" [1/16"]	1701-00-39	1/4" – 1 3/8" [1/16"]	1801-00-39	1" – 1 3/4" [1/16"]	1593-00-39	1/4" – 1 1/4" [1/16"]
Round Metric	1717-00-17	1–42mm [1mm]	1701-00-17	7–51mm [1mm]	1801-00-17	15–65mm [1mm]	1593-00-17	5–40mm [1mm]
Hex Metric	1717-00-27	3–36mm [1mm]	1701-00-27	6–40mm [1mm]	—	—	—	—
Square Metric	1717-00-37	3–29mm [1mm]	—	—	—	—	—	—
Rd. Serrated Fractional	1717-00-59	1/16" – 1 1/8" [1/32"]	1701-00-59	1/2" – 2" [1/16"]	1801-00-59	1/2" – 2 1/2" [1/16"]	1593-00-59	3/8" – 1 5/8" [1/32"]
Round Serrated Metric	1717-00-57	12–42mm [5mm]	1701-00-57	10–50mm [1mm]	1801-00-57	15–65mm [1mm]	—	—

NOTE: Increments in brackets. 3J Collets 1/64" and under are 3 split. 3J Collets over 1 23/32" do not have internal stop threads. 16C Collets 1.615" and over do not have internal stop threads. 16C Collets are four split.



5C, 16C, 20C and 25C Collet Sets

Hardinge Special-Accuracy 5C Collet Sets are enclosed in a handsome walnut case with a certificate of accuracy signed by the President of Hardinge. Each collet in the set is tested in a Hardinge spindle and guarantees a maximum TIR of .0002" (.005mm). Sets are available in 1/64", 1/32" and .5mm increments.

Standard-Accuracy Sets are available for 5C, 16C, 20C and 25C collets. These sets include our standard collets attractively priced and packaged in quantities that will outfit your machine nicely. Walnut box not included with Standard Accuracy Sets - see collet racks on page 27.

Collet Sets

Type	Part Number: All Sizes With Internal Stop Threads	Part Number: Above 5/64" Have No Internal Threads	Increment	Quantity	Size & Range Stocked	Accuracy
5C - Round Fractional	0901-07-00-000000	0901-00-00-000000	1/64"	65 collets	1/16" to 1 1/16"	Standard Accuracy
5C - Round Fractional	0903-07-00-000000	0903-00-00-000000	1/64"	65 collets	1/16" to 1 1/16"	Special Accuracy (.0002" TIR)
5C - Round Fractional	0902-07-00-000000	0902-00-00-000000	1/32"	33 collets	1/16" to 1 1/16"	Standard Accuracy
5C - Round Fractional	0904-07-00-000000	0904-00-00-000000	1/32"	33 collets	1/16" to 1 1/16"	Special Accuracy (.0002" TIR)
5C - Round Metric	0908-07-00-000000	0908-00-00-000000	.5mm	51 collets	2mm to 27mm	Standard Accuracy
5C - Round Metric	0909-07-00-000000	0909-00-00-000000	.5mm	51 collets	2mm to 27mm	Special Accuracy (.005mm TIR)
16C - Round Fractional	0913-00-00-000000	—	1/8"	8 collets	1/8" - 1 1/2"	Standard Accuracy
16C - Round Fractional	0915-00-19-000000	—	1/8"	12 collets	1/4" - 1 5/8"	Standard Accuracy
16C - Round Fractional	0917-00-19-000000	—	1/16"	23 collets	1/4" - 1 5/8"	Standard Accuracy
20C - Round Fractional	0919-00-19-000000	—	1/8"	16 Collets	1/8" - 2"	Standard Accuracy
20C - Round Fractional	0921-00-19-000000	—	1/16"	31 collets	1/8" - 2"	Standard Accuracy
25C - Round Fractional	0925-00-19-000000	—	1/16"	33 collets	1/2" - 2 1/2"	Standard Accuracy
25C - Round Fractional	0923-00-19-000000	—	1/8"	17 collets	1/2" - 2 1/2"	Standard Accuracy

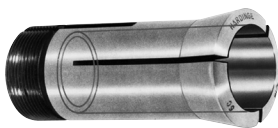

The **SC Step Collet** permits the use of the Hardinge threaded positive stops. The step depth varies depending on the collet capacity.

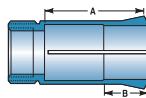

Step Collets – 5C-SC and 16C-SC

Type	Part Number	Size Range	A - Max Depth	B - Length
5C Round	1001-07-19-	1" to 1 1/16"	2 3/8" (60.33)	3/4" (19.05)
5C Round	1001-07-19-	1 5/64" to 1 1/8"	1 1/2" (38.10)	1" (25.40)
5C Hexagon	1001-07-29-	55/64" to 29/32"	2 3/8" (60.33)	3/4" (19.05)
5C Hexagon	1001-07-29-	15/16" to 31/32"	1 1/2" (38.10)	1" (25.40)
5C Hexagon	1001-07-29-	1"	1 1/2" (38.10)	1/2" (12.70)
5C Square	1001-07-39-	23/32" to 3/4"	2 3/8" (60.33)	3/4" (19.05)
16C Round	91717-07-19-	Over 1 5/8" to 1 11/16" inclusive	2 7/8" (73.03)	1 3/8" (34.93)
16C Round	91717-07-19-	Over 1 11/16" to 1 3/4" Inclusive	1 3/4" (44.45)	1 3/4" (44.45)
16C Hexagon	91717-07-29-	Over 1 13/32" to 1 25/64" inclusive	2 7/8" (73.03)	1 3/8" (34.93)
16C Hexagon	91717-07-29-	Over 1 29/64" to 1 33/64" inclusive	1 3/4" (44.45)	1 3/4" (44.45)
16C Square	91717-07-39-	Over 1 5/16" to 1 3/16" inclusive	2 7/8" (73.03)	1 3/8" (34.93)
16C Square	91717-07-39-	Over 1 3/16" to 1 5/16" inclusive	1 3/4" (44.45)	1 3/4" (44.45)

NOTE: Millimeters in parentheses. 5C-SC step collets have internal stop threads. Part numbers preceded by 9 are special order.

5C Extended-Nose Collets (Standard TIR: .001", 1/2" from Face)



5C Hardened, Precision-Machined Extended-Nose Collets

are for the same applications as regular collets. The extended-nose permits deeper counter-bores and tool clearance for extended work. Extended-nose collets have internal threads for Hardinge positive stops.

Type	Part Number	Figure	Size Range	A - Maximum Depth
Round Fractional	8015-00-19-	1	1/16" to 1 1/4" [1/64"]	Thru Hole; No Step
		1	1/16" to 29/32" 1	2" (50.80)
		2	3/4" to 1 1/16" 1	1 1/2" (38.10)
Round Metric	8015-00-17-	1	2mm to 32mm [.5mm]	Thru Hole; No Step
		1	3mm to 18mm 1	2" (50.80)
		2	20mm to 28mm 1	1 1/2" (38.10)

NOTE: Increments in brackets. Special Accuracy Collet now available in 8015 style, .0005" TIR at 1/2" from Face. 1 - Diameter of face is order hole plus 1/4" (6.35mm)

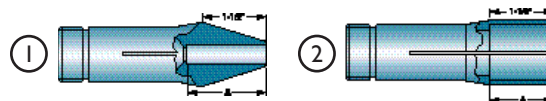

Emergency Collets



Even with the best of planning, emergencies arise when your tool room and production departments require a stepped, odd size or special-shape collet. On such occasions, use the Hardinge® **Emergency Collet**. The soft face and pilot hole permit rapid drilling, boring or stepping out to the exact size required. Pins are supplied for precision machining. Emergency collets have internal threads for positive stops.

Extended-Nose Emergency Collets permit deeper counter bores when required, and tool clearance for extended work. Extended-nose emergency collets also have internal threads for positive stops. The collet shank section of a **5C Emergency Plug Chuck** is finished for direct application to your machine spindle. The nose section can be machined in place for the greatest degree of accuracy to suit your particular requirements for special arbors.

Emergency Collets – 3C & 5C

3C Model	Part Number	5C Model	Part Number	Material	Pilot Hole	Slots
3C Blank	1583-10-00	5C Blank	1001-10-00-000000	Steel	—	—
3C-E1	1585-12-10	5C-E1	1007-12-10-000000	Steel	1/16" (1.59)	Specify 3 or 4
—	—	5C-E1	1013-12-10-000000	Brass	1/16" (1.59)	3
3CE	1585-14-10	—	—	Steel	1/4" (6.35)	4
3C-E2	1585-13-00	5C-E2	1007-13-10-000000	Steel	1/8" (3.18)	3
—	—	5C-E2	1007-13-10-000004	Steel	1/8" (3.18)	4
—	—	5C-E2	1013-13-10-000000	Brass	1/8" (3.18)	3
3C-E0	1585-11-00	5C-E0	1007-11-00-000000	Steel	—	3

Emergency Collets – 16C, 20C, 25C & 3J

Model	Part Number	Pilot Hole
16C Emergency Collets - 3 Slots		
16C-E	1717-14-00-000000	1/4" (6.35)
16C-E1	1717-12-00-000000	1/16" (1.59)*
16C-E2	1717-13-00-000000	1/8" (3.18)
16C-E0	1717-11-00-000000	—
20C Emergency Collets - 4 Slots		
20C-E	1701-14-10-000000	1/4" (6.35)
20C-E0	1701-11-00-000000	—
25C Emergency Collets - 4 Slots		
25C-E	1801-14-10-000000	1/2" (12.70)
25C-E0	1801-11-00-000000	—
3J Emergency Collets - 4 Slots		
3J-E	1595-14-10-000000	1/4" (6.35)
3J-E1	1595-12-10-000000	1/16" (1.59)
Replacement Pins		
3C	7721-00-00	—
5C, 16C, 20C & 3J	7723-00-00	—
25C	7725-00-00	—

* Specify 3 or 4 slots

NOTE: Millimeters in parentheses.

3J Collets 1/16" and under are 3 split.

3J Collets over 1²³/₃₂" have no internal thread.

Emergency collets not intended to be heat treated.

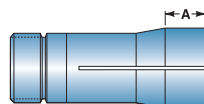

Extended-Nose Emergency Collets

Model	Part Number	Pilot Hole	A – Length
3C Emergency Collets - 3 Slots			
3C-EN1	1795-14-10-	1/4" (6.35)	1" (25.40)
3C-EN1-2	1795-13-10-	1/8" (3.18)	1" (25.40)
3C-EN2	1797-14-10-	1/4" (6.35)	1/2" (12.70)
5C Emergency Collets - 3 Slots			
5C-EN1	1009-14-10-000000	1/4" (6.35)	1" (25.40)
5C-EN1-1	1009-12-10-000000	1/16" (1.59)	1" (25.40)
5C-EN1-2	1009-13-10-000000	1/8" (3.18)	1" (25.40)
5C-EN2	1011-14-10-000000	1/4" (6.35)	1/2" (12.70)
5C-EN2-1	1011-12-10-000000	1/16" (1.59)	1/2" (12.70)
5C-EN2-2	1011-13-10-000000	1/8" (3.18)	1/2" (12.70)
3C & 5C Emergency Plug Chuck - Solid			
3C Plug	1587-00-00-	—	1" (25.40)
5C Plug	1015-00-00-000000	—	1 3/4" (44.45)
16C Emergency Collets - 3 Slots			
16C-EN1	1717-12-13-000000	1/4" (6.35)	1" (25.40)
16C-EN1-1	1717-13-13-000000	1/16" (1.59)	1" (25.40)*
16C-EN1-2	1717-14-13-	1/8" (3.18)	1" (25.40)
16C-EN2	1717-12-14-	1/4" (6.35)	1/2" (12.70)
16C-EN2-1	1717-13-14-	1/16" (1.59)	1/2" (12.70)*
16C-EN2-2	1717-14-14-	1/8" (3.18)	1/2" (12.70)
20C Emergency Collets - 4 Slots			
20C-EN .75	1809-14-10-	1/4" (6.35)	3/4" (19.05)
20C-EN 1.5	1811-14-10-	1/4" (6.35)	1 1/2" (38.10)
3J Emergency Collets - 4 Slots			
3J-EN1	1593-12-13-	1/4" (6.35)	1" (25.40)
3J-EN2	1593-12-14-	1/4" (6.35)	1/2" (12.70)
Replacement Pins			
All Sizes	7731-00-00	—	—

* Specify 3 or 4 slots



Kellenberger 5C Collet Adaptation Chuck

An adapter with draw tube permits the use of 5C spindle tooling on Kellenberger grinding machines. Use with collets, step chucks and Sure-Grip expanding collet systems. This system features the standard Hardinge threaded-nose design.

Part Number 0957-00-00-000000

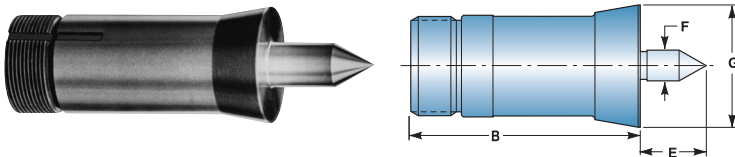
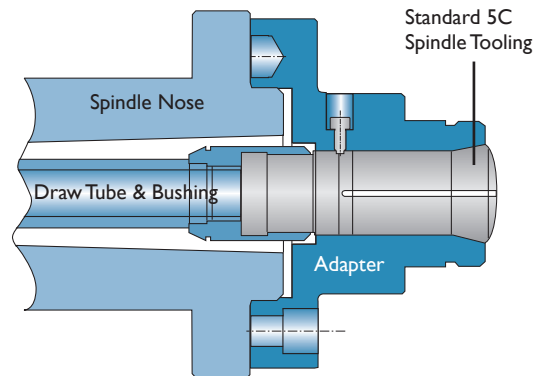

Headstock Centers – Male Center

Style	Model	Part Number	B	E	F	G
5C	G9-5C	57-0000296	3 $\frac{3}{8}$ " (81.35)	1 $\frac{9}{32}$ " (30.93)	.570" (14.47)	1.470" (37.33)
16C	AK-7	AK-0000296-16C	4.344" (110.33)	1.250" (31.75)	.570" (14.47)	2.250" (57.15)
20C	AK-13	AK-0000296-20C	4.940" (125.47)	1.250" (31.75)	.570" (14.47)	2.880" (73.15)
25C	AK-19	AK-0000296-25C	5.000" (127.00)	1.250" (31.75)	.570" (14.47)	3.464" (87.98)

NOTE: Millimeters in parentheses.

5C LensMaker Collets

Collet	Part Number	Diameter	Depth
5C LM (3 Split)	8277-01-18-005010	.501"	$\frac{1}{16}$ "
5C LM (3 Split)	8277-02-18-005010	.501"	$\frac{1}{8}$ "
5C LM (6 Split)	8279-01-18-005010	.501"	$\frac{1}{16}$ "
5C LM (6 Split)	8279-02-18-005010	.501"	$\frac{1}{8}$ "

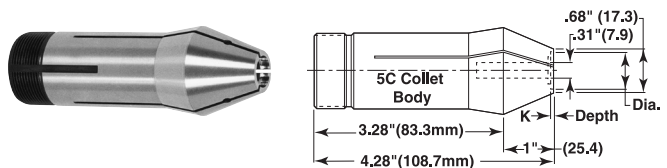

5C-ST Long Bearing Drill Collets – Hardened, Precision-Machined

Type	Part Number	Size Range
Letter	1017-00-16-	A to Z inclusive
Number	1017-00-15-	1 to 78 inclusive
Fractional	1017-00-19-	$\frac{1}{64}$ " to $1\frac{1}{8}$ " inclusive by $\frac{1}{64}$ " increments
Metric	1017-00-17-	3mm to 25mm by .5mm increments

NOTE: 5C-ST collets have longer bearing surface than standard 5C collets and do not have internal stop threads.

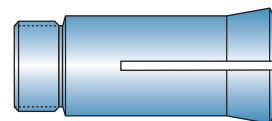

5C Step Chucks & Closers



Step Chucks are used for accurately holding work up to 6" in diameter. Castings, moldings, stampings and machined parts are held rigidly and accurately. Tubing can be held without crushing or distorting. Accurate gripping, the same as with collets, is yours when you use regular- and extra-depth capacity step chucks for holding larger diameters.

Regular-Depth Step Chucks are $\frac{3}{8}$ " larger in diameter than the rated size so the full capacity may be readily applied to a depth of $\frac{1}{2}$ ". A regular-depth step chuck closer is required for each rated size.

Extra-Depth Step Chucks are made so the full rated capacity may be applied to a depth of $1\frac{1}{4}$ ". An extra-depth step chuck closer is required for each rated size. Small closing angles are available on step chucks for non-rotating use.

Step Chuck Closers are required when using step chucks on rotating spindles. Step chuck closers fit directly to the machine spindle. An inside taper corresponding to that on the step chuck places the closing pressure over the stepped area of the chuck, resulting in greater gripping power and accuracy. When ordering step chuck closers, specify for taper or threaded nose for 5C models or A2-4, A2-5, A2-6, A2-8 spindle noses. A step chuck closer is required for each rated size step chuck. The closer mounts directly on the spindle nose.

5C Regular-Depth Step Chucks and Closers – $\frac{1}{2}$ " / 12.70mm Max. Depth of Step

Step Chuck Rated Size Dia. x Depth	Part Number	Figure	Material	Slots	Small Closing Angle	Taper Closer ²	Threaded Closer ²
2" x $\frac{1}{2}$ "	1389-00-19-000000 ¹	1	Steel	3	Yes	1421-26-00-000000	1421-00-00-000000
3" x $\frac{1}{2}$ "	9-1483-00-00-000000	2	Steel	3	No	1423-26-00-000000	1423-00-00-000000
4" x $\frac{1}{2}$ "	9-1485-00-00-000000	2	Steel	3	No	1425-26-00-000000	1425-00-00-000000
5" x $\frac{1}{2}$ "	9-1487-00-00-000000	2	Steel	3	No	1427-26-00-000000	1427-00-00-000000
6" x $\frac{1}{2}$ "	9-1489-00-00-000000	2	Steel	3	No	1429-26-00-000000	1429-00-00-000000

1 - Available in round sizes $1\frac{1}{16}$ " to 2" inclusive by $\frac{1}{16}$ " increments.
 2 - For Emergency and Hardened, Precision-Machined Step Chucks.
 NOTE: Part numbers preceded by a 9 are special order.

Spanner Wrench for Step Chuck Closers Part #460-0009189

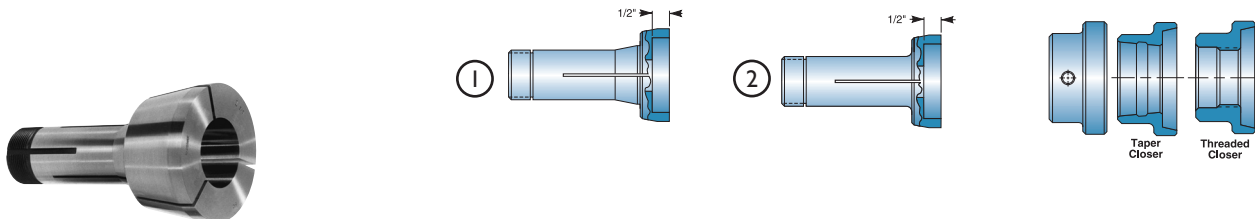

5C Extra-Depth Step Chucks and Closers – $1\frac{1}{4}$ " / 31.75mm Max. Depth of Step

Step Chuck Rated Size Dia. x Depth	Part Number	Material	Slots	Small Closing Angle	Taper Closer ²	Threaded Closer ²
2" x $1\frac{1}{4}$ "	1391-00-19-000000 ¹	Steel	3	No	1433-26-00-000000	1433-00-00-000000
3" x $1\frac{1}{4}$ "	9-1491-00-00-000000	Steel	3	No	1435-26-00-000000	1435-00-00-000000
4" x $1\frac{1}{4}$ "	9-1493-00-00-000000	Steel	3	No	1437-26-00-000000	1437-00-00-000000
5" x $1\frac{1}{4}$ "	9-1495-00-00-000000	Steel	3	No	1439-26-00-000000	1439-00-00-000000
6" x $1\frac{1}{4}$ "	9-1497-00-00-000000	Steel	3	No	1441-26-00-000000	1441-00-00-000000

1 - Available in round sizes $1\frac{1}{8}$ " to 2" inclusive by $\frac{1}{16}$ " increments.
 2 - For Emergency and Hardened, Precision-Machined Step Chucks
 NOTE: Part numbers preceded by a 9 are special order..

Spanner Wrench for Step Chuck Closers Part #460-0009189

CAUTION: Closers are required for all rotating step chuck applications. See page 40 for spindle rpm safety information.

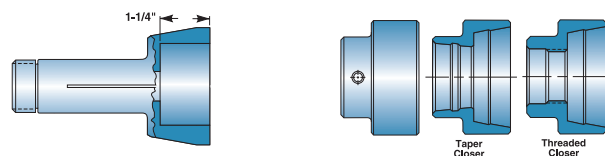

Emergency Step Chucks are made for those situations where time does not allow for the ordering of a hardened step chuck. Emergency step chucks are supplied with pin holes and pins in place for precision machining. Pins are located beyond the maximum rated capacity of the step chuck—this permits stepping the chuck to its full capacity without cutting into the pins. Pins can be used, removed and saved for additional stepping operations.

Regular-Depth Step Chucks are $\frac{3}{8}$ " larger, while **Extra-Depth Step Chucks** are $\frac{3}{4}$ " larger in diameter than the rated size so the full capacity bore may be easily machined. A regular-depth step chuck can be bored to a maximum depth of $\frac{1}{2}$ ", the extra-depth step chuck to a maximum depth of $1\frac{1}{4}$ " with $1\frac{3}{4}$ " step for the 25C step chuck. A regular- or extra-depth step chuck closer is required for each rated size.

Hardinge Emergency Step Chucks are not designed to be heat treated by the customer. Step chucks with small closing angles are available for use with stationary (non-rotating) workholding devices only. All 5C taper and threaded-nose closers are made from cast iron. All other closers are made of steel.

5C Emergency Regular-Depth Step Chucks and Closers – $\frac{1}{2}$ " / 12.70mm Maximum Depth

Step Chuck Rated Size Dia. x Depth	Part Number	Figure	Material	Slots	Small Closing Angle	Taper Closer	Threaded Closer
2" x $\frac{1}{2}$ "	1351-00-10-000000	1	Steel	3	Yes	1421-26-00-000000	1421-00-00-000000
2" x $\frac{1}{2}$ "	1351-25-00-000000	2	Steel	—	Yes	1421-26-00-000000	1421-00-00-000000
2" x $\frac{1}{2}$ "	1377-00-10-000000	1	Steel	4	Yes	1421-26-00-000000	1421-00-00-000000
3" x $\frac{1}{2}$ "	1353-00-10-000000	1	Steel	3	Yes	1423-26-00-000000	1423-00-00-000000
4" x $\frac{1}{2}$ "	1355-00-10-000000	1	Steel	3	Yes	1425-26-00-000000	1425-00-00-000000
4" x $\frac{1}{2}$ "	1369-00-10-000000	3	Steel	3	No	1425-26-00-000000	1425-00-00-000000
5" x $\frac{1}{2}$ "	1357-00-10-000000	1	Steel	3	Yes	1427-26-00-000000	1427-00-00-000000
5" x $\frac{1}{2}$ "	1371-00-10-000000	3	Steel	3	No	1427-26-00-000000	1427-00-00-000000
6" x $\frac{1}{2}$ "	1359-00-10-000000	1	Steel	3	Yes	1429-26-00-000000	1429-00-00-000000
6" x $\frac{1}{2}$ "	1373-00-10-000000	3	Steel	3	No	1429-26-00-000000	1429-00-00-000000
7" x $\frac{1}{2}$ "	1375-00-10-000000	3	Steel	3	No	1431-26-00-000000	1431-00-00-000000

Replacement Pins Part #7723-00-00-000000. Spanner Wrench for Step Chuck Closers Part #460-0009189.



5C Emergency Extra-Depth Step Chucks and Closers – $1\frac{1}{4}$ " / 31.75mm Maximum Depth

Step Chuck Rated Size Dia. x Depth	Part Number	Figure	Material	Slots	Small Closing Angle	Taper Closer	Threaded Closer
2" x $1\frac{1}{4}$ "	1379-00-10-000000	1	Steel	3	Yes	1433-26-00-000000	1433-00-00-000000
2" x $1\frac{1}{4}$ "	1379-25-00-000000	2	Steel	—	Yes	1433-26-00-000000	1433-00-00-000000
3" x $1\frac{1}{4}$ "	1381-00-10-000000	3	Steel	3	No	1435-26-00-000000	1435-00-00-000000
4" x $1\frac{1}{4}$ "	1383-00-10-000000	3	Steel	3	No	1437-26-00-000000	1437-00-00-000000
5" x $1\frac{1}{4}$ "	1385-00-10-000000	3	Steel	3	No	1439-26-00-000000	1439-00-00-000000
6" x $1\frac{1}{4}$ "	1387-00-10-000000	3	Steel	3	No	1441-26-00-000000	1441-00-00-000000

Replacement Pins Part #7723-00-00-000000. Spanner Wrench for Step Chuck Closers Part #460-0009189.

CAUTION: Closers are required for all rotating step chuck applications. See page 40 for spindle rpm safety information.

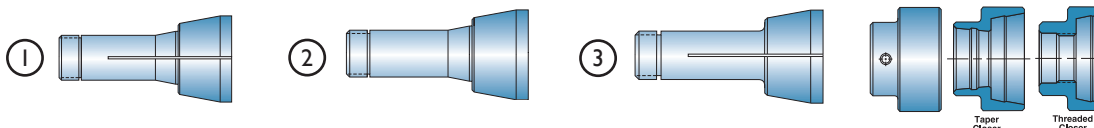

A2, 5C Emergency Step Chucks

Hardinge® **Emergency Step Chucks** used on A2-5 and A2-4 5C spindles have the same criteria as regular step chucks except the shank is longer. The closers are made of steel.

- The A2-4 Closer is used on the Hardinge QUEST® GT and CHNC 27 Lathe
- The A2-5 Closer is used on the older Hardinge CHNC®-5C and HXL (A2-5 5C spindle – the same closer used on all A2-5, 16C Spindles)

Because these 5C Step Chucks have a longer shank than standard 5C Step Chucks, they can only be used on Hardinge CONQUEST GT, QUEST GT, CHNC 27, CHNC-5C and HXL A2-5 5C lathes. A2-4 and A2-5 hardened, precision-machined step chucks are available as special orders.



A2-5 and A2-4 — 5C Emergency **Regular-Depth** Step Chucks & Closers — ½" / 12.70mm Maximum Depth

Step Chuck Rated Size Dia. x Depth	Part Number	Material	Slots	Small Closing Angle	Closer for A2-5 CHNC-5C and HXL-5C	Closer for A2-4 QUEST GT
2" x ½"	1263-00-00-000000	Steel	3	No	16-0002682	5-0002682
3" x ½"	1251-00-00-000000	Steel	3	No	16-0002683	5-0002683
4" x ½"	1265-00-00-000000	Steel	3	No	16-0002684	5-0002684
5" x ½"	1253-00-00-000000	Steel	3	No	16-0002685	—
6" x ½"	1255-00-00-000000	Steel	3	No	16-0002686	—

NOTE: The shank of these step chucks are longer than standard 5C step chucks. Replacement Pins Part #7723-00-00-000000. Bolts for Closers: A2-4 & A2-5 Part # – MS-0104019 (M10 x 1.5 x 25)

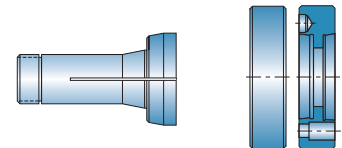

A2-5 and A2-4 – 5C Emergency **Extra-Depth** Step Chucks & Closers — 1¼" / 31.75mm Maximum Depth

Step Chuck Rated Size Dia. x Depth	Part Number	Material	Slots	Small Closing Angle	Closer for A2-5	Closer for A2-4 QUEST GT
2" x 1¼"	1267-00-00-000000	Steel	3	No	16-0002682-OC	5-0002682-OC
3" x 1¼"	1257-00-00-000000	Steel	3	No	16-0002683-OC	5-0002683-OC
4" x 1¼"	1269-00-00-000000	Steel	3	No	16-0002684-OC	5-0002684-OC
5" x 1¼"	1259-00-00-000000	Steel	3	No	16-0002685-OC	—
6" x 1¼"	1261-00-00-000000	Steel	3	No	16-0002686-OC	—

NOTE: The shank of these step chucks are longer than standard 5C step chucks. Replacement Pins Part #7723-00-00-000000. Bolts for Closers: A2-4 & A2-5 Part # – MS-0104019 (M10 x 1.5 x 25)

CAUTION: Closer required for all rotating step chuck applications.

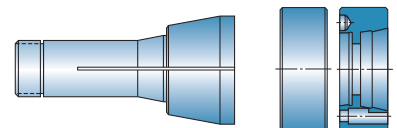

16C Hardened, Precision-Machined **Regular-Depth** Step Chucks & A2-5 Closers – 1/2" / 12.70mm Max. Depth

Rated Size Dia. x Depth	Step Chuck Part Number	Figure	Closer Part Number	Figure
2" x 1/2"	9-1273-00-00-00000	1	16-0002682	2
3" x 1/2"	1215-00-19-0000001	1	16-0002683	2
4" x 1/2"	9-1217-00-00-00000	1	16-0002684	2
5" x 1/2"	9-1219-00-00-00000	1	16-0002685	2
6" x 1/2"	9-1221-00-00-00000	1	16-0002686	2

1 - Available from stock in round sizes 1 1/8" to 3" inclusive by 1/16" increments. NOTE: All closers made of steel. Part numbers preceded by a 9 are special order.

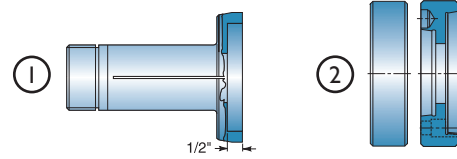

16C Hardened, Precision-Machined **Extra-Depth** Step Chucks & A2-5 Closers – 1/4" / 31.75mm Max. Depth

Rated Size Dia. x Depth	Step Chuck Part Number	Figure	Closer Part Number	Figure
2" x 1/4"	9-1277-00-00-00000	3	16-0002682-OC	4
3" x 1/4"	9-1223-00-00-00000	3	16-0002683-OC	4
4" x 1/4"	9-1225-00-00-00000	3	16-0002684-OC	4
5" x 1/4"	9-1227-00-00-00000	3	16-0002685-OC	4
6" x 1/4"	9-1229-00-00-00000	3	16-0002686-OC	4

NOTE: All closers made of steel. Part numbers preceded by a 9 are special order. CAUTION: Closer required for all rotating step chuck applications.

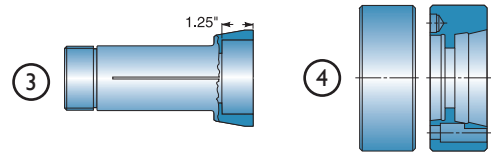

16C & 3J Emergency **Regular-Depth** Step Chucks & 16C A2-5 Closers – 1/2" / 12.70mm Maximum Depth

Rated Size Dia. x Depth	16C Step Chuck Part Number	Figure	A2-5 Closer Part Number	Figure	3J Step Chuck Part Number	Figure
2" x 1/2"	1275-39-00-000000	5	16-0002682	6	1597-00-10-000000	7
3" x 1/2"	1231-39-00-000000	5	16-0002683	6	1599-00-10-000000	7
4" x 1/2"	1233-39-00-000000	5	16-0002684	6	1649-00-00-000000	7
5" x 1/2"	1235-39-00-000000	5	16-0002685	6	1725-00-00-000000	7
6" x 1/2"	1237-39-00-000000	5	16-0002686	6	1659-00-00-000000	7

NOTE: All closers made of steel. 3J Step Chucks do not require a closer. Replacement Pins Part #7723-00-00-000000. WARNING: 3J step chucks have no large closing angle, therefore, centrifugal force will severely reduce gripping force as the rpm increases.

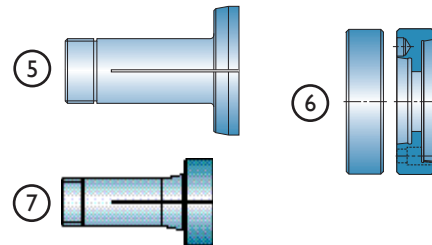

16C, 20C and 25C Emergency **Extra-Depth** Step Chucks & Closers (A2-5, A2-6, A2-8)

Rated Size Dia. x Depth	16C 1-1/4"	20C 1-1/4"	25C 1-3/4"	Figure	16C	20C	25C		Figure
	Step Chuck Part Number	Step Chuck Part Number	Step Chuck Part Number		A2-5 Closer Part Number	A2-6 Closer Part Number	A2-6 / A2-8 Closer Part Number		
2" x 1/4"	1281-39-00-	—	—	3	16-0002682-OC	—	QUEST® A2-6	Others A2-8	4
3" x 1/4"	1241-39-00-	1283-00-00-	—	3	16-0002683-OC	20-0002683-OC	—	—	4
4" x 1/4"	1243-39-00-	1285-00-00-	1287-00-00-	3	16-0002684-OC	20-0002684-OC	2995-00-	1443-00-	4
5" x 1/4"	1245-39-00-	—	—	3	16-0002685-OC	—	—	—	4
6" x 1/4"	1247-39-00-	1289-00-00-	1293-00-00-	3	16-0002686-OC	20-0002686-OC	2997-00-	1445-00-	4
8" x 1/4"	OA	OA	1447-00-10-	3	OA	OA	2999-00-	1449-00-	4

NOTE: Millimeters in parentheses. OA = On Application. Replacement Pins Part #7723-00-00-000000. Emergency step chucks not intended to be heat treated.

CAUTION: Closer required for all rotating step chuck applications.

Closer Mounting Bolt Part Numbers:
 16C 0101216
 20C MS-0104219
 25C MS-0104620

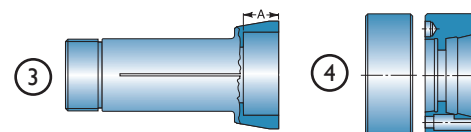

3C/4C Emergency Step Chucks



Emergency step chucks are made of soft, machineable steel, while closers are made of cast iron. Step chucks with small closing angles are available for use in stationary (non-rotating) workholding devices. Contact us for more information.

1300-series part numbers listed below are Hardinge® standard 3C and 4C Step Chucks made to order – other models will be quoted upon application.

3C & 4C Regular-Depth Step Chucks & Closers

Rated Size & Type	Standard Item	Step Chuck Part Number	Figure	Slots	Small Closing Angle	Closer – Tapered	Closer – Threaded Fig 5
2" 3C	x	1301-00-10-000000	1	3	Yes	1401-26-00-000000	1401-00-00-000000
2" 3C		HS-4300	2	—	Yes	1401-26-00-000000	1401-00-00-000000
3" 3C		HS-4301	3	—	No	1403-26-00-000000	1403-00-00-000000
3" 3C	x	1307-00-10-000000	4	3	No	1403-26-00-000000	1403-00-00-000000
4" 3C		HS-4302	3	—	No	1405-26-00-000000	1405-00-00-000000
4" 3C	x	1309-00-10-000000	4	3	No	1405-26-00-000000	1405-00-00-000000
5" 3C		HS-4303	3	—	No	1407-26-00-000000	1407-00-00-000000
5" 3C		37-2625-A	4	3	No	1407-26-00-000000	1407-00-00-000000
6" 3C		HS-4304	3	—	No		
6" 3C		37-0002626-A	4	3	No		
2" 4C	x	1320-00-00-000000	2	—	Yes	1411-26-00-000000	1411-00-00-000000
2" 4C	x	1321-00-10-000000	1	3	Yes	1411-26-00-000000	1411-00-00-000000
3" 4C		HS-4306	3	—	No	1413-26-00-000000	1413-00-00-000000
3" 4C	x	1323-00-10-000000	2	3	No	1413-26-00-000000	1413-00-00-000000
4" 4C		8946D	3	—	No	1415-26-00-000000	1415-00-00-000000
4" 4C		47-2624-A	4	3	No	1415-26-00-000000	1415-00-00-000000
5" 4C		HS-4308	3	—	No	1417-26-00-000000	1417-00-00-000000
5" 4C		47-2625-A	4	3	No	1417-26-00-000000	1417-00-00-000000
6" 4C		HS-4309	3	—	No		

CAUTION: Closers are required for all rotating step chuck applications. See page 40 for spindle rpm safety information.

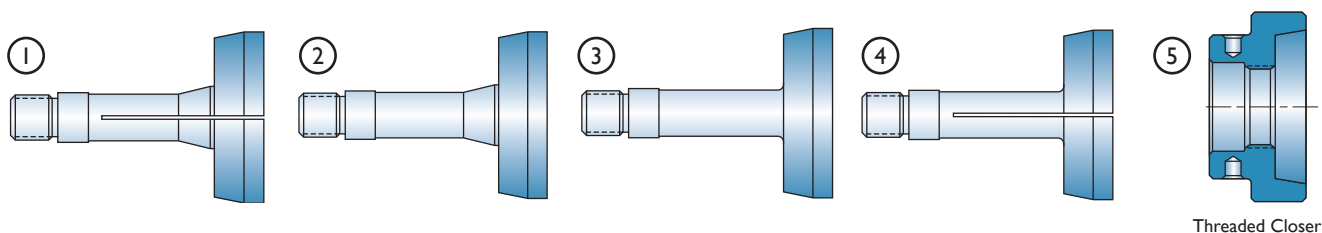

Threaded Closer

Threaded Positive Solid Stops

Style	Description	Part Number	Model	A – Depth
5C	Solid Stop Assembly	1049-00-00-000000	SS-5C	3/4" (73.38)
	Body	1051-00-00-000000		
	Nut	5A-0001466-C		
	Threaded Stop ¹	1053-00-00-000000		
16C	Solid Stop Assembly	1805-00-00-000000	SS-16C	3/4" (95.25)
	Body	1807-00-00-000000		
	Nut	1185-00-00-000000		
	Threaded Stop ¹	1183-02-00-000000		
16C	Adapter-Style Assembly	1199-00-00-000000	—	3/4" (95.25)
	Body	1051-00-00-000000		
	Adapter Bushing	1155-01-00-000000		
	Nut	5A-0001466-C		
16C	Threaded Stop (1/2" diameter) ¹	1071-00-00-000000		
	Adapter Bushing	1155-01-00-000000		
20C	Solid Stop Assembly	1279-00-00-000000	20C-SS	5/8" (149.23)
	Body	1278-00-00-000000		
	Nut	1185-00-00-000000		
	Threaded Stop ¹	1271-00-00-000000		
25C	Solid Stop Assembly	1073-00-00-000000	25C-SS	6/8" (155.58)
	Body	1075-00-00-000000		
	Nut	1185-00-00-000000		
	Threaded Stop ¹	1271-00-00-000000		
3J	Solid Stop Assembly	1999-00-00-000000	—	3" (76.2)
	Body	1051-00-00-000000		
	Adapter Bushing	1995-00-00-000000		
	Threaded Stop ¹ (1/2" Dia.)	1071-00-00-000000		
	Nuts [2]	5A-0001466-C		
22J	Solid Stop Assembly	1719-00-00-000001	22J-SS	3/4" (92.07)
	Body	1719-00-00-000002		
	Nut	1185-00-00-000000		
	Threaded Stop ¹	1271-00-00-000000		



The standard Hardinge® collet comes with a deep, precision-threaded section at the rear of the capacity bore to permit the use of Hardinge positive solid and ejector stops. Purchase a standard collet and it is always ready for stop work since the threaded capacity bore is found in all fractional, decimal, hexagon, square, rectangular and emergency Hardinge collets within the ranges listed. The Hardinge solid, ejector and long threaded stops are threaded into and positively locked against the end of the collet. Once locked in place, the stop cannot move even under heavy drilling or other end-working pressures. The three types of stops permit a wide variety of chucking work since all are adjustable and machinable for the desired part length to the maximum workpiece depths indicated.

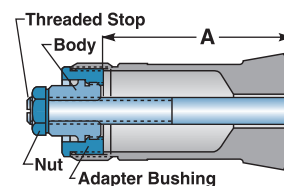
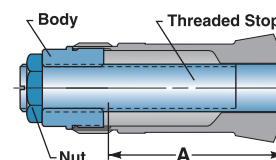

16C Adapter-style Solid Stop Assembly

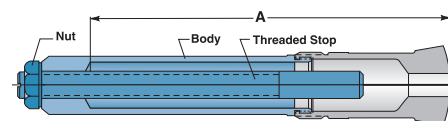

Long Stop Assembly

Long Stops

Long Stop	5C	16C	20C / 25C	3J
Assembly Part Number	1067-00-00-000000	1213-00-00-000000	N/A	2003-00-00-000000
Model	LS-5C	LS-16C	—	—
A – Depth	7/8" (190.50)	7/4" (184.15)	—	7/8" (200)
Body	1069-00-00-000000	1181-02-00-000000	—	1997-00-00-000000
Threaded Stop ¹	1071-00-00-000000	1183-02-00-000000	—	1183-02-00-000000
Nut	5A-0001466-C	1185-00-00-000000	—	1185-00-00-000000

1- Threaded stops can be altered to different lengths.

NOTE: Millimeters in parentheses.

Ejector Stops

Ejector Stop	5C	16C	20C / 25C	3J
Assembly Part Number	1057-00-00-000000	1155-00-00-000000	N/A	2001-00-00-000000
Model	ES-5C	ES-16C	—	ES-3J
A – Dimension	2 3/4" (69.85)	3 3/8" (85.73)	—	3 3/8" (85.73)
Body	1059-00-00	1059-00-00	—	1059-00-00
Plunger	1061-00-00	1061-00-00	—	1061-00-00
Insert	1063-00-00	1063-00-00	—	1063-00-00
Spring	1065-00-00	1065-00-00	—	1065-00-00
Adpt bushing	—	1155-01-00 ¹	—	1995-00-00 ¹
Nuts [2]	U-0004141-C	U-0004141-C	—	U-0004141-C

1- Use AF7 wrench (7559)

NOTE: Millimeters in parentheses.

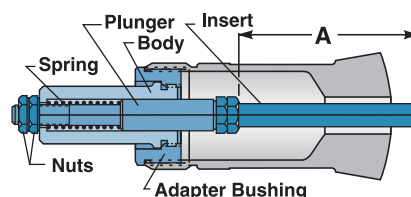

Collets are not included in assemblies.

5C/16C Universal Collet Stops

5C Universal Collet Stop Set

The Hardinge® Universal Collet Stop Set will convert Hardinge 5C collets without internal threads into Solid Stop or Spring Ejector Stop Collets. The two solid inserts and the two inserts for the spring ejector housing can be machined to suit varying requirements. The front end of the collet stop body has a standard 1/2-20 thread for convenient application of other sizes and special-shaped stops. The solid inserts of the spring ejector are adjustable in or out in the stop body to arrive at the desired chucking depth. The locking screw and brass plug hold the insert or spring ejector in the predetermined position. Once that is done, merely place the collet stop in the back of the collet and tighten the lock screw—see illustration. This causes the locking plugs to securely anchor the collet stop inside the collet. Application does not require machining of the collet—the stop is merely placed in the collet.

5C Universal Collet Stop Set

Description	Part Number	Figure	Model
Universal Stop Set -	1019-00-00-000000		G10
Includes:			
Collet Stop Body	1029-00-00-000000		RX-107-F
Locking Screw	1031-00-00-000000		RX-107-G
Nut	U-0004141-C		
Lock Pins [6]	1021-00-00-000000		RX-107-A
Retaining Spring	1025-00-00-000000		RX-107-C
Plug	N37-0000483		
Screw	0550303		
Solid Insert, 9/16" Dia. ¹	1023-00-00-000000	A	RX-107-B
Solid Insert, 1/4" Dia. ¹	1027-00-00-000000	B	RX-107-E
Plunger, 9/16" Dia. ¹	1035-00-00-000000	C	RX-107-L
Plunger, 1/4" Dia. ¹	1037-00-00-000000	D	RX-107-N
Spring for Plunger	1039-00-00-000000		RX-107-R
Spring Ejector Body	1033-00-00-000000		RX-107-H
Screw	0100306		

1 - Can be altered to different lengths. NOTE: Millimeters in parentheses.

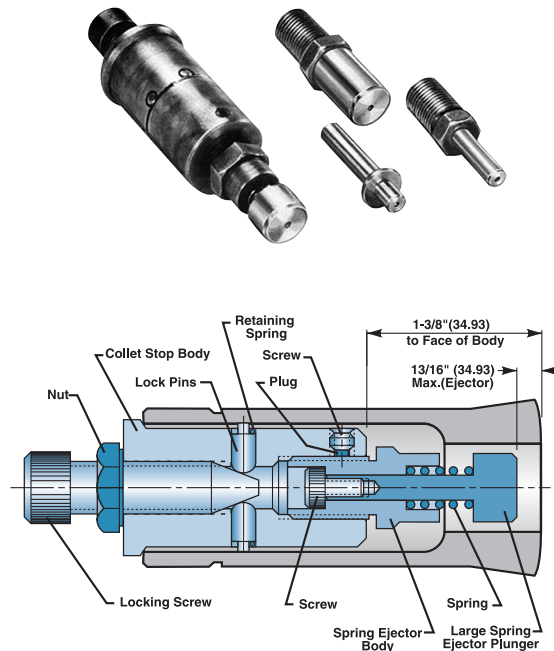

16C Universal Stop – Draw-Tube Style

Description	Part Number
Universal Stop Assembly - includes:	1717-66-00-000000
Plug	1717-66-01-000000
Body	1717-66-02-000000
Nut	1717-66-03-000000
10 - 32" x 9/16" Set Screws [3]	0570303
5/32" x 1/16" Nylon Plugs [3]	N370000483
Pusher	1717-66-04-000000
Ringspan Disks	1717-66-08-000000
1/2" - 13 Jam Nut	MD 0003182
Short Stop Rod	1717-66-05-000000
Long Stop Rod	1717-66-06-000000
End Stop	1717-66-07-000000
O-Ring	OR 0002427

NOTE: Unit is mounted in the draw tube of the collet closer.

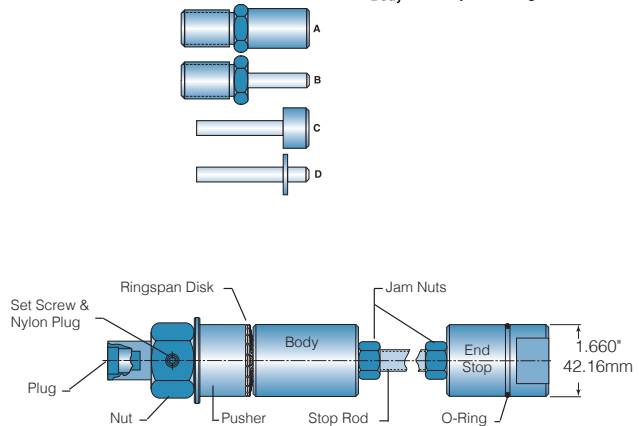

Stop Wrench for Collet Body



Description	5C Part Number	16C Part Number	20C Part Number	25C Part Number	3J Part Number
Collet Stop Wrench	ST-0011759	CC-0011759	CL-0011759-A	7605-00-00	ST-0011759-01
Model Number	G-15	16C-15	20C-15	25C-15	3J-15
Body	ST-0004025-02	CC-0004025	CL-0004025-01	7609-00-00	ST-0004025
Handle	ST-0006239	CC-0006239	CC-0006239	CC-0006239	CC-0006239
Key	ST-0011006	ST-0011006	CL-0011006	CL-0011006	ST-0011006-01

Hardinge® Dead-Length Collet Assembly

Shoulders and faces can be machined to exact length, regardless of OD variations with the Hardinge Dead-Length Collet Assembly. Parts are loaded against an adjustable solid stop which is threaded into the inner collet. The inner collet, in turn, is spring-loaded against the spindle face. There is no end movement.

The low-cost inner collet has a soft face and pilot hole to permit boring to size in the machine spindle for exacting concentricity. The inner collet is pinned to the outer collet to maintain location and original bored accuracy.

Dead-Length Collets can be used on all machines and attachments with a 5C/16C spindle and draw bar. The outer collet, solid stop, spring and nut are interchangeable between the Dead-Length Collet and the Dead-Length 2" Step Chuck on the following page. The complete assembly is a one time purchase; after that, buy the inner collet only.



5C Dead-Length Collet Assembly

Description	Part Number	Model	A – Chucking Diameter	B – Maximum Depth of Stop	C – Pilot Hole or Bore Size
Emergency Collet Assembly:	1157-00-00-000000	5DS-71			
Outer Collet Assembly excludes the Dead-Length Inner Collet – Includes parts listed below:	1157-02-00-000000	5DS-71			
Spring	1165-00-00-000000				
Spring Retainer	1163-00-00-000000				
Nuts [2]	U-0004141-C				
Outer Collet	1161-00-10-000000	5DS-71-3			
Threaded Stop	3263-00-00-000000				
Stop Body	3261-00-00-000000				
Emergency Dead-Length Inner ¹ Collet, 1/8"	1159-00-10-000000	5DS-71-1	Under 7/8" (22.23)	2 1/8" (53.98)	1/8" (3.18)
Other Available Collets					
Emergency Dead-Length Collet, 1/32"	1159-11-00-000000		Under 7/8" (22.23)	2 1/8" (53.98)	1/32" (.79)
Hardened Collet	1159-00-19-000000	5DS-71-1HG	Under 7/8" (22.23)	2 1/8" (53.98)	Order Size
Solid Stop Assembly	3259-00-00-000000	11-9150			

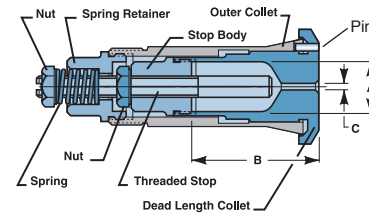

¹ - Dead-Length Inner Collet sold separately.

NOTE: Millimeters in parentheses. Replacement Pins Part #7721.

16C Dead-Length Collet Assembly

Description	Part Number	Model	A – Chucking Diameter	B – Maximum Depth of Stop	C – Pilot Hole or Bore Size
16C Emergency Collet Assembly:	1171-00-00-000000	16DS-80	1 13/32" (35.72) and under	2" (50.80)	1/8" (3.18)
Outer Collet Assembly excludes the Dead-Length Inner Collet – Includes parts listed below:	1171-02-00-000000				
Spring	1187-00-00-000000				
Spring Retainer	1189-00-00-000000				
Nuts [2]	1185-00-00-000000				
Outer Collet	1177-00-00-000000	16DS-80-03			
Threaded Stop	1183-02-00-000000				
Stop Body	1181-01-00-000000				
Emergency Dead-Length Inner Collet	1173-13-00-000000	16DS-80-01			

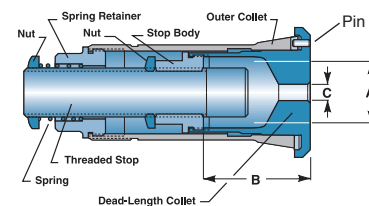

¹ - Dead-Length collet sold separately.

NOTE: Millimeters in parentheses. Replacement Pins Part Number: 7721.

Dead-Length® Step Chucks

Hardinge® Dead-Length Step Chucks will accommodate larger chucking diameters. Shoulders and faces can be machined to exact length, regardless of OD variations with the Hardinge Dead-Length Step Chucks. The low-cost step chuck has a soft face and pilot hole to permit boring to size in the machine spindle for exacting concentricity. The step chuck is pinned to the outer collet to maintain location and original bored accuracy.

Dead-Length Step Chucks can be used on all machines and attachments with a 5C/16C spindle and draw bar. The outer collet, solid stop, spring and nut are inter-changeable between the Dead-Length Collet and the Dead-Length 2" Step Chuck. The complete assembly is a one time purchase; after that, buy the step chuck only.



Dead-Length Emergency Step Chucks

Description	5C Part Number	16C Part Number	20C Part Number	A – Chucking Diameter	AA – Chucking Diameter	B – Maximum Depth of Stop	C – Maximum Pilot Hole
Emergency Step Chuck Assembly:	1167-00-00-000000	1179-00-00-000000	2041-00-00-000000				
Model	5DS71SC	16DS80SC	20DS				
Outer Collet Assembly excludes the Dead-Length Inner Step Chuck – Includes parts listed below:	1157-02-00-000000	1171-02-00-000000	2041-02-00-000000				
Spring	1165-00-00-000000	1187-00-00-000000	1187-00-00-000000				
Spring (Belleville) [2] 20C Only			AM901170				
Spring Retainer	1163-00-00-000000	1189-00-00-000000	1815-00-00-000000				
Nuts [2]	U-0004141-C	1185-00-00-000000	1185-00-00-000000				
Outer Collet	1161-00-10-000000	1177-00-00-000000	2039-00-0-0000000				
Threaded Stop (Stop Rod)	3263-00-00-000000	1183-02-00-000000	1271-00-00-000000				
Stop Body	3261-00-00-000000	1181-01-00-000000	1813-00-00-000000				
Dead-Length Inner Step Chuck							
5C	1169-00-10-000000			2" (50.80)	7/8" (22.23)	2 5/8" (66.67)	1/4" (6.35)
16C		1175-00-00-000000		2 3/4" (69.85)	1 13/32" (35.72)	2 5/8" (66.67)	1/4" (6.35)
20C			2037-00-00-000000	3 1/2" (88.90)	1 3/4" (44.45)	3 1/2" (88.9)	1/4" (6.35)

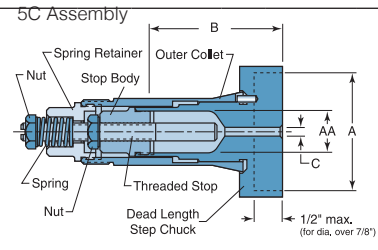

NOTE: Millimeters in parentheses. Emergency Collets not intended to be heat treated. Hardened, precision-machined collets are available upon application. To set spring tension, compress coil spring completely by hand, then back off nut one turn.

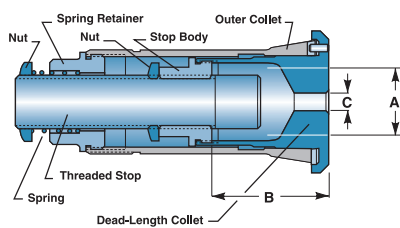

16C Assembly

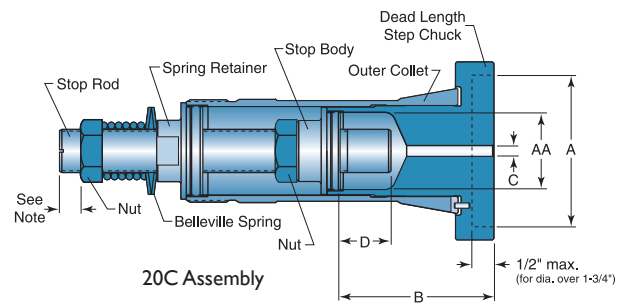

20C Assembly

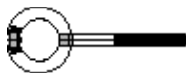

Collet Stop Wrench for Outer Collet

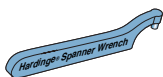

Inner Collet Spanner



Adjustable Face Spanner for Spring Retainer

Wrenches, Spanners & Pins for Dead-Length Collet Assemblies

Part Name	5C Part Number	16C Part Number	20C Part Number
Collet Stop Wrench	ST-0011759	CC-0011759	CL-0011759-A
Inner Collet Spanner Wrench	7893-00-00-000000 ¹	7895-00-00-000000 ²	7897-00-00-000000 ³
Adjustable Face Spanner	—	7891-00-00-000000 ¹	—
Pins (3) for DL Collet – 5C, 16C	7721-00-00-000000	7721-00-00-000000	7721-00-00-000000
Pins (3) for Step Chuck – 5C, 16C, 20C	7723-00-00-000000	7723-00-00-000000	7723-00-00-000000

1 – 3/16" pin, 2 – 7/32" pin, 3 – 1/4" pin



Dead-Length Thru-Hole Collets

Thru-hole collets are ideal for bar work and long workpieces. Bar stock up to $\frac{3}{4}$ " in diameter can pass "through" the 5C collet, while maintaining part length control. The 16C Collet allows for bar stock up to $1\frac{3}{16}$ ". With the Dead-Length Collet feature, the bar stock will not draw back from the stock stop.

In use, the outer collet threads directly into the collet closer draw bar. The bar stock is then fed through the collet and located against the turret-mounted stock stop. As the closer is actuated, the draw bar pulls the outer collet into the machine spindle, allowing the inner collet to contract and accurately grip the stock. Because the inner collet is spring-loaded against the spindle face, no end movement is possible.

Hardened, precision-machined or emergency collets can be used as the inner collet. The 5C hardened, precision-machined collets are available in sizes $\frac{1}{32}$ " to $\frac{3}{4}$ ", inclusive by $\frac{1}{32}$ " increments. Over-capacity sizes, available for chucking work are: $\frac{25}{32}$ ", $1\frac{1}{16}$ ", $\frac{27}{32}$ ", and $\frac{7}{8}$ " (cannot be used for bar work). The low-cost emergency inner collet has a soft face with pins for machining and a $\frac{1}{8}$ " pilot hole to permit boring to size in the machine spindle for exacting concentricity. The inner collet is keyed to the outer collet to maintain location and original bored accuracy. The pins used for machining can be saved for stepping out the collet on future jobs.

Buy the complete assembly one time, and then just buy the inner collets when needed. Use in any machine or fixture with a 5C/16C spindle and collet draw bar.

Dead-Length Thru-Hole Collet (Not Available for 20C or 25C)

Description	5C Part Number	16C Part Number	A – Pilot Hole	Round	Hexagon	Square
Emergency Collet Assembly:	1157-01-00-000000	1171-01-00-000000		<input checked="" type="radio"/>	<input type="radio"/>	<input type="radio"/>
Model Number	5DS-71-TR	16C-80-DTCL				
Outer Collet Assembly excludes	1157-01-01-000000	—				
Inner Dead-Length Collet – Includes parts listed below:						
Spring	1133-00-00-000000	16A-00081015C				
Spring Retainer	1131-00-00-000000	1171-01-02-000000				
Nuts [2]	1157-06-00-000000	1171-01-03-000000				
Outer Collet	1161-00-00-000000	1177-00-00-000000				
Guide Body	1129-00-00-000000	1171-01-01-000000				
Inner Dead-Length Collets						
5C Emergency Dead-Length Collet	1159-00-10-000000		$\frac{1}{8}$ " (3.18)	$\frac{3}{4}$ " (19.05)	$\frac{41}{64}$ " (16.27)	$\frac{17}{32}$ " (13.50)
5C Hardened Precision DL Collet ²	1159-00-19-000000			$\frac{3}{4}$ " (19.05)	$\frac{41}{64}$ " (16.27)	$\frac{17}{32}$ " (13.50)
16C Emergency Dead-Length Collet		1173-13-00-000000	$\frac{1}{8}$ " (3.18)	$1\frac{1}{16}$ " (30.16)	$1\frac{1}{64}$ " (25.80)	$\frac{53}{64}$ " (21.03)
16C Hardened Precision DL Collet		1173-00-19-000000		$1\frac{1}{16}$ " (30.16)	$1\frac{1}{64}$ " (25.80)	$\frac{53}{64}$ " (21.03)

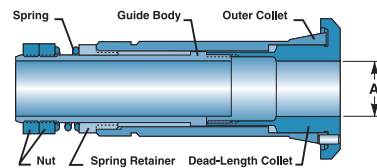

1 – Dead-Length collet sold separately. 2 – Available in $\frac{1}{32}$ " increments.

NOTE: Millimeters in parentheses. Part numbers preceded by 9 are special order.

Dead-Length® Collet Ejector Stops



5C Ejector



16C Ejector

- Ideal for second operation work
- Kicks part out into part chute when collet is opened
- Ejects part into step collet and holds it against shoulder while collet is closing
- Ejects part into a feed finger style parts transfer device
- One time purchase of complete assembly; after that, buy only the "Stop for Plunger"

5C and 16C Dead-Length Collet Ejector Stop Assembly

Description	Key	5C D.L. Ejector Stop Part Number	16C D.L. Ejector Stop Part Number
Ejector Assembly Only - No Collets **		2165-00-00-000000	2175-00-00-000000
Ejector Stop Assembly - Complete		2161-00-00-000000	2171-00-00-000000
Ejector Assembly & Outer Collet *		2163-00-00-000000	2173-00-00-000000
Ejector Assembly Step Chuck - Complete		2157-00-00-000000	2159-00-00-000000
Parts List - Components			
Nut/nuts1	1	2169-00-00-000000	2179-00-00-000000
Belville Springs [2]	2	N/A	CE-1750057
Large Spring	3	CE-0975105-1250	CE-1100105-0875
Spring Retainer	4	1131-00-00-000000	2181-00-00-000000
Outer Collet	5	1161-00-10-000000	1177-00-00-000000
Small Nut	6	U-0004141-C	U-0004141-C
Small Spring	7	1065-00-00-000000	1065-00-00-000000
Heavy Small Spring	7	—	CE-0000054
Plunger	8	1061-00-00-000000	1061-00-00-000000
Ejector Body	9	2167-00-00-000000	2177-00-00-000000
Emergency Dead-Length Collet	10	1159-00-10-000000	1173-00-00-000000
Hardened, Precision Dead-Length Collet	10	1159-00-19-00Size	On Application
Collet			
Dead-Length Step Chuck	10	1169-00-10-000000	1175-00-00-000000
Stop for Plunger	11	1063-00-00-000000	2183-00-00-000000

** Includes Parts: 1, 2, 3, 4, 6, 7, 8, 9 and 11; * Includes Parts: 1, 2, 3, 4, 5, 6, 7, 8, 9 and 11

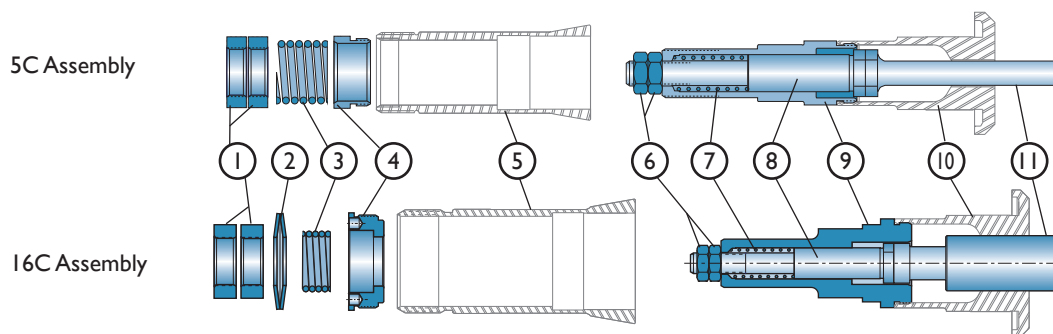

The **Dead-Length Spider-Stop Step Chuck** is designed to handle workpieces larger than the capacity of the Dead-Length 16C Collet or Step Chuck. The spider stop slides through oversize slots in the step chuck and locates against the collet seat in the machine's 16C spindle. A stop button screws into the spider stop and can be machined to locate against the reference location on the workpiece. This system requires a standard extra-depth step chuck closer.



The Spider-Stop Step Chuck has only one moving part — the step chuck. This allows for much better concentricity than the standard Dead-Length Collet System, even for smaller diameter workpieces. The Step Chuck is first machined to the chucking diameter of the workpiece and to a depth to accommodate the stop button. The stop button is machined to the locating surface of the workpiece. The stop button is assembled. The unit is mounted into the spindle of the machine that already has the appropriate step chuck closer mounted. With the collet closer in the open position and the workpiece held against the stop button, the draw tube is turned until the step chuck just grips the workpiece and then backed off 1/2 a turn. The part should easily load into the step chuck. The collet closer is locked in this position. With the part firmly located against the stop button, the step chuck is closed. It is important that the stop button be lightly faced after the unit is mounted in the spindle to ensure extremely precise perpendicularity with the locating surface.

16C Dead-Length Spider-Stop Step Chuck

Description	Part Number	Figure	A – Maximum Bore Depth	B – Maximum Chucking Dia.	C – Maximum Chucking Depth
3" ED Emergency Dead-Length Step Chuck Assembly	1331-00-00-000000	1	1.250" (31.75)	3.00" (76.20)	1.000" (25.40)
3" ED Emergency Dead-Length Step Chuck	1327-00-00-000000	1			
3" Stop Button	1137-00-00-000000	1			
Spider-Stop Assembly, Includes:	1239-00-00-000000	1			
Spider Stop Fins*	1325-00-00-000000	1			
Draw Rod	1349-00-00-000000	1			
Adapter Bushing	1155-01-00-000000	1			
Spring Retainer	1163-00-00-000000	1			
Spring	1165-00-00-000000	1			
Nut [2]	U 0004141	1			
3" 16C ED Hardened Step Chuck Closer (sold separately)	16-0002683-OC	2			
4" ED Emergency Dead-Length Step Chuck Assembly	1367-00-00-000000	1	1.250" (31.75)	4.00" (101.60)	1.000" (25.40)
4" ED Emergency D.L. Step Chuck	1329-00-00-000000	1			
4" Stop Button	1319-00-00-000000	1			
Spider-Stop Assembly (Parts Shown Above)	1239-00-00-000000	1			
4" 16C ED Hardened Step Chuck Closer (sold separately)	16-0002684-OC	2			

* 1/2"-20TPI (Internal Thread) x 3/8" (15.9mm) deep can be used for customer made extensions.

NOTE: Millimeters in parentheses.

Initial Order Requires: One 3" or 4" Emergency Dead-Length Step Chuck Assembly and one 3" or 4" Extra-Depth Hardened Step Chuck Closer.

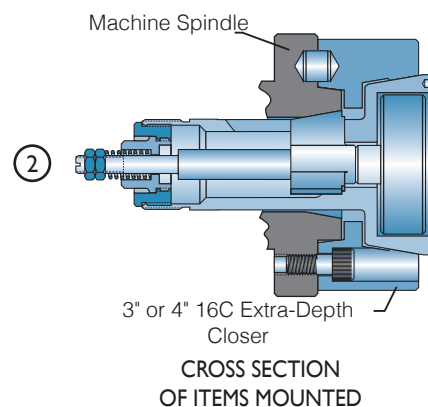
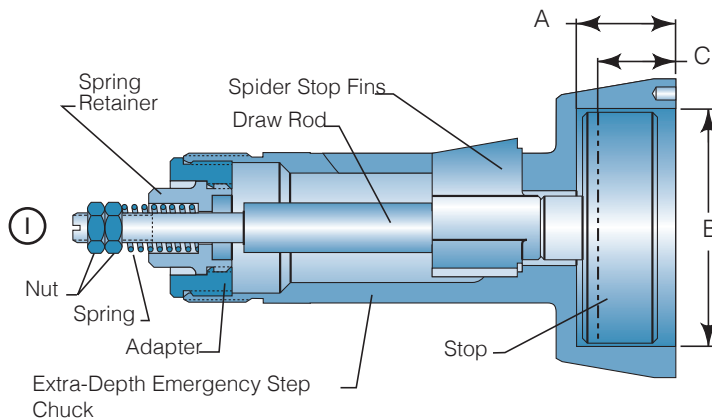

Style "S" Master Collets & Pads



S12 Master Collet and Pads

S16, S20, S26 Master Collet and Closer

The **Style "S" Master Collet**, although originally designed for first operation machining on multi-spindle automatic screw machines, has many benefits to the CNC lathe operator. The collet pads can be changed much quicker than a standard solid collet, the cost is less and it requires much less storage space. Depending on size, the TIR for the master collet and pads is .004" to .008".

The Style "S" Master Collet System with Hardened, Precision collet pads should not be used for secondary work because of the system's large TIR. Some customers are successful using emergency pads which they bore to size on the machine tool. Choose from soft emergency or semi-hard emergency pads for longer wear. When the pads are removed from the master collet and then replaced, they may again runout excessively. Emergency collets are used again when re-bored to sizes larger than the original bore.

Style "S" Master Collets and Pads

Style	Master Part Number	Fig	Extra-Depth Closer Part Number	Pad Part Number	A – Back Bearing Diameter	B – Overall Length	C – Collet Face Diameter	D – Thread	Round	Hexagon	Square
S10 (B42)	5205-00-	2	—	5601	1.887" (47.93)	3.688" (93.68)	2.355" (59.82)	M43 x 1	1" (25.40)	59/64" (21.83)	49/64" (17.86)
S12 (16C)	1717-01-	1	—	5603	1.889" (47.98)	4.625" (117.48)	2.265" (57.53)	1.870" x 1.75 mm RH	1 1/4" (31.75)	1 1/16" (26.99)	7/8" (22.23)
S16 (16C)	1717-02-	3	16-0002683-OC	5607	1.889" (47.98)	6.453" (163.91)	3.875" (98.43)	1.870" x 1.75 mm RH	1 5/8" (41.28)	1 13/32" (35.72)	1 3/64" (28.97)
S20 (20C)	1249-00-	3	20-0002683-OC	5609	2.378" (60.33)	8.388" (213.06)	3.750" (95.25)	2.359" / M60 x 1.5mm RH	2" (50.80)	1 23/32" (43.66)	1 13/32" (35.72)
S26 (20C)	3605N as a special			5613	2.378" (60.33)	8.813" (223.85)	4.750" (120.65)	2.359" / M60 x 1.5mm RH	2 5/8" (66.68)	2 17/64" (57.55)	1 27/32" (46.83)
S22 (B65) ¹	5311-00-	2	—	5611	2.832" (71.93)	4.328" (109.93)	3.603" (91.51)	M66 x 1	2 1/4" (57.15)	1 15/16" (49.21)	1 37/64" (40.08)
S26 (25C)	1291-00-	4	1443-00-00-000000	5613	2.930" (74.42)	9.020" (229.11)	4.926" (125.38)	2.871" / M73 x 1.5mm RH	2 5/8" (66.68)	2 17/64" (57.55)	1 27/32" (46.83)

¹ - Uses Clamp Assembly 7627 (3 ea.) in parentheses.

NOTE: Millimeters

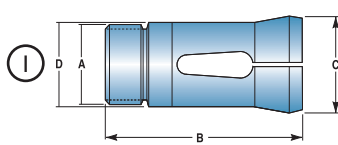

Internal stop thread is 1.687" x 20 RH.

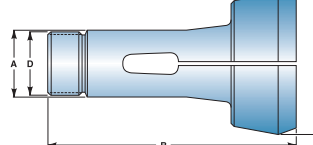
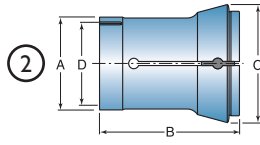

Internal stop thread is 1.687" x 20 RH. An extra depth closer is required

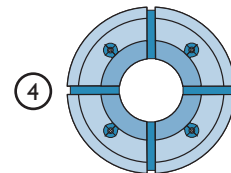

S26 Collet & Pads

Style "S" Pads – Standard, Soft Emergency, Semi-hard Emergency

Description	Round Smooth Part Number	Round Serrated Part Number	Round Metric Part Number	Hexagon Part Number	Square Part Number	Emergency Part Number	Semi-Hard Emerg. Part Number
S10 Pads	5601-00-19-	5601-00-59-	5601-00-57-	5601-00-29-	5601-00-39-	5601-14-10-	—
S12 Pads	5603-00-19-	5603-00-59-	5603-00-57-	5603-00-29-	5603-00-39-	5603-14-10-	5603-13-10
S16 Pads	5607-00-19-	5607-00-59-	5607-00-57-	5607-00-29-	5607-00-39-	5607-14-10-	5607-13-10
S20 Pads	5609-00-19-	5609-00-59-	5609-00-57-	5609-00-29-	5609-00-39-	5609-14-10-	5609-13-10
S22 Pads	5611-00-19-	5611-00-59-	5611-00-57-	5611-00-29-	5611-00-39-	5611-14-10-	5611-13-10
S26 Pads	5613-00-19-	5613-00-59-	5613-00-57-	5613-00-29-	5613-00-39-	5613-14-10-	5613-13-10

NOTE: Other pad configurations available.

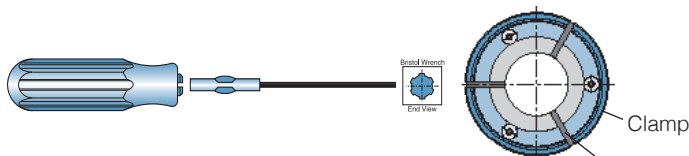

S10, S12, S16, S20 & S26 Collet & Pads

Description	Part Number
Bristol Wrench Handle	7909-00-00-000010
Wrench .111"	7909-00-00-000001
Wrench .145"	7909-00-00-000002
Bristol "L" Wrench	7637-00-00-000000
Bristol Wrench Handle	7909-00-00-000013
Seal (Sold by the dozen)	7643-00-00-010000
Clamp Assembly 3 ea. (S26 4 ea.)	7619-00-00-000000
Clamp Assembly for S22 (3 ea.)	7627-00-00-000000



The Hardinge® Super-Precision® **Master Expanding Collet** is a valuable aid for close tolerance machining. There is no end movement of the master expanding collet or pads. The collet threads are separate from the collet body and pull back to operate the expander. The shoulder on the machineable pads locates the work for Dead-Length® control for facing repetitive parts to the same length. No spindle nose cap is required.

The master collet is hardened and precision-machined. The pads are soft for turning in the machine spindle for exacting concentricity. Depending on job application, pads may be machined for internal gripping from ¼" to 3" ID. The limit ring is used to stabilize the pads while turning to the desired diameter. Pad segments and master collet are stamped "A", "B" and "C" for replacement positioning. The pads may be re-machined for smaller diameters. Can be used on all machines or attachments with a 5C or 16C spindle and operates with the standard draw spindle (bar). The collet body assembly and the limit rings are a one-time purchase. After that, you only have to order the low-cost pads.

Master Expanding Collet Assembly – 5C and 16C

Description	5C Part Number	16C Part Number
Master Expanding Collet Assembly ¹ – includes parts listed below:	1139-00-00-000000	1191-00-00-000000
Expanding Collet Body	1141-00-00-000000	1193-00-00-000000
Draw Thread	1143-00-00-000000	1195-00-00-000000
Draw Plug	1145-00-00-000000	1197-00-00-000000
Spring	1151-00-00-000000	1151-00-00-000000
Screw	0100306	0100306
Nut	U-0004141-C	U-0004141-C
Model Number	5EC-70	16EC-80

1 - Requires master pad set and appropriate limit ring; each sold separately.

Master Expanding Collet Pad Sets – ¼" to 3" (6.35 to 76.20mm) Capacity

Description	Part Number	Model	Pad Capacity	A – Gripping Diameter	B – Maximum Turned Length
2" Steel Master Pad Set ²	1147-00-00-000000	5EC-70-4	2" (50.80)	Over 1½" to 2" (38.10 to 50.80) [A1]	1¼" (26.99) [B1]
			2" (50.80)	Over ¾" to 1½" (9.53 to 38.10) [A2]	¾" (19.05) [B2]
			2" (50.80)	¼" to ¾" (6.35 to 9.53) [A3]	Equal to Diameter Turned [B3]
Limit Ring for 2" Pads	1149-00-00-000000				
3" Aluminum Master Pad Set ²	1153-00-00-000000	5EC-70-7	3" (76.20)	Over 2" to 3" (50.80 to 76.20) [A1]	1½" (41.27) [B1]
			3" (76.20)	Over 1½" to 2" (38.10 to 50.80) [A2]	1¼" (26.99) [B2]
			3" (76.20)	¾" to 1½" (19.05 to 38.10) [A3]	¾" (19.05) [B3]
Limit Ring for 3" Pads	1111-22-00-000000				

2 - Requires limit ring.

NOTE: Millimeters in parentheses.

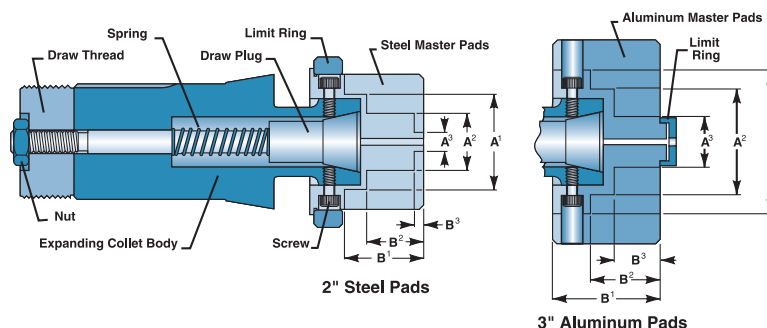

Precision Expanding Collets



The Model-S Expanding collet draw plug expands at the front of the collet, resulting in maximum gripping force in the bore of a small diameter workpiece. For larger diameter workpieces, Hardinge recommends the Sure-Grip® Expanding Collet System.

Model-S Precision Expanding Collets

Precision internal chucking simplifies your tooling and machining operations. Precision results are assured when many operations are done in one chucking. The Model-S expanding collet assembly is precision engineered for small inside diameter chucking.

Concentricity requirements, like all machining specifications, are very rigid. With the Hardinge expanding collet unit, it is easy to obtain concentric and square shoulders, faces and diameters with a previously machined bore. The Hardinge expanding collet adjusts to meet your most exacting requirements by means of four concentricity adjusting screws. Exact lengths are easily obtained since both the stationary expanding collet and work locating stop have no end movement. The work locating stop is machined in place during machine set up, assuring an absolutely square locating surface. When the collet is in the released position, it is smaller in diameter than the bore of the part. The result is fast and easy loading and unloading.

5C and 16C Model-S Expanding Collet Assembly — 3/8" to 3/4" (9.52 to 19.05mm) by 1/64" Increments

Description	Part Number	Fig.	Model	A – Back Bearing Outside Diameter	B – Overall Length	D – Thread
5C Model-S Assembly ¹						
- Taper	1077-26-00-000000	1a				
- Threaded	1077-00-00-000000	1a				
includes parts below:						
Draw Collet	1079-00-00-000000	2	E-206	1.249" (31.72)	3.250" (82.55)	1.238" x 20 RH
Draw Plug	1081-00-00-000000	3	ES-207	.254" (6.45)	2.750" (69.85)	.245" x 28 RH
Spindle Collar:		1a				
- Taper-Nose	1083-00-00-000000		E-211			
- Threaded-Nose	1085-00-00-000000		E-211-D			
- A2-4 and A2-5	Special Order					
Adjusting Screw	0570510					
Cap Screw	0100308					
16C Model-S Assembly ¹	1205-02-00-000000	1b				
includes parts below:						
Draw Collet	1209-02-00-000000	2		1.889" (47.98)	4.312" (109.53)	1.870" x 1.75 mm RH
Draw Plug	1081-16-00-000000	3		.220" (5.59)	2.969" (75.41)	7 mm x .75 RH
Spindle Collar	16-0000211-A201	1b				
Adjusting Screws [4]	0550710	1b				
Cap Screws [3]	0100308	1b				
Mounting Bolts [4]	0101216	1b				
Model-S Expanding Collet ²	1089 (fractional/decimal)	4	MP3461	2.255" (57.28)	1.750" (44.45)	
Work-Locating Stop ³	1087-00-00-000000	5	ES-209	2.312" (58.72)	1.218" (30.94)	
Spanner for Spindle Collars, 5/16" Pin	460-0009189					

- 1 - Requires Model-S Expanding collet sold separately.
- 2 - Required with assembly. Available in Round sizes 3/8" to 3/4" by 1/64" increments.
- 3 - Optional. Recommended for positive part location.



Spanner for Spindle Collars

NOTE: Millimeters in parentheses.

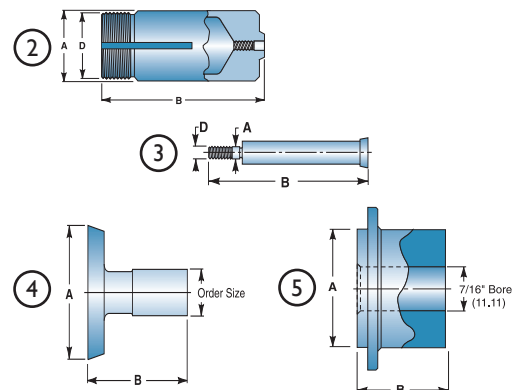
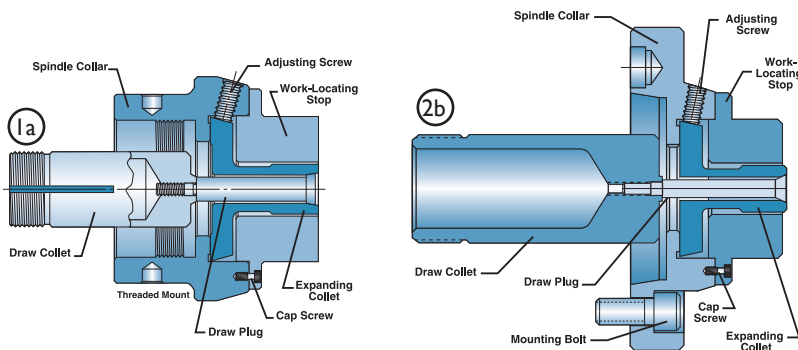

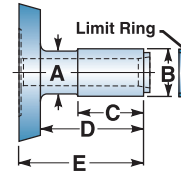
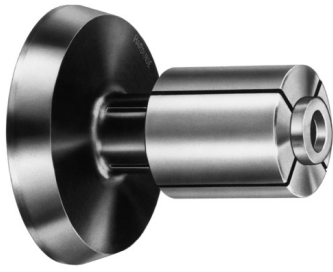

Model-S Emergency Expanding Collets

Part Description	Number	Model	A – Neck Turned Range	B – Gripping Diameter	C – Gripping Length	D – Face to Length	E – Shoulder Depth	Length
Model-S Emergency Expanding Collet ¹	1093-00-00	S-E	.562" to .750" (14.27 to 19.05)	.547" (13.89)	.766" (19.46)	.906" (23.01)	1.281" (32.54)	1.656" (42.06)
Limit Ring	1093-22-00	MP3461C						

¹ - Limit Ring required

Note: Millimeters in parentheses.



Sure-Grip® Expanding Collet Systems

The Hardinge **Sure-Grip® Expanding Collet System** is ideal for internal gripping of larger diameter bores. The Sure-Grip system has a larger gripping range and considerably more gripping force due to its true parallel closing. Refer to models 200, 250, 300, 400, 500 and 600 in **brochure #2270**.

Advantages of the Sure-Grip Expanding Collet System...

- Instant centering of the arbor—no adjustment needed after mounting
- Quick changeover
- Wide gripping range for each collet
- True parallel gripping even when gripping on half the collet body
- High gripping force
- Light gripping on small parts with bores down to 1/8" (3.175mm)
- Built-in safety stop to prevent the collet from overexpanding
- Exact part length control
- Consistency in collet capacity for different spindle styles (interchangeable collets)
- Delivery in 3 to 5 days

Collet & Step Chuck Adapters



Collet adapters let you use smaller collets in machines with larger collet seats. Units are available to adapt 5C collets to 16C spindles, 16C collets to 20C and 25C spindles and 16C step chucks to 20C spindles. These units are valuable when you do not have the proper size standard collet for the machine but do have the proper size in a smaller style collet. Do not consider this unit when doing precision work. Because of the number of parts in the assembly, the TIR of the machined diameters to the chucked diameters may be unacceptable. This system should not be considered when doing many collet changes a day. It may take from 15 to 30 minutes to change a collet. It is more cost effective to purchase the proper style collet for the machine tool.

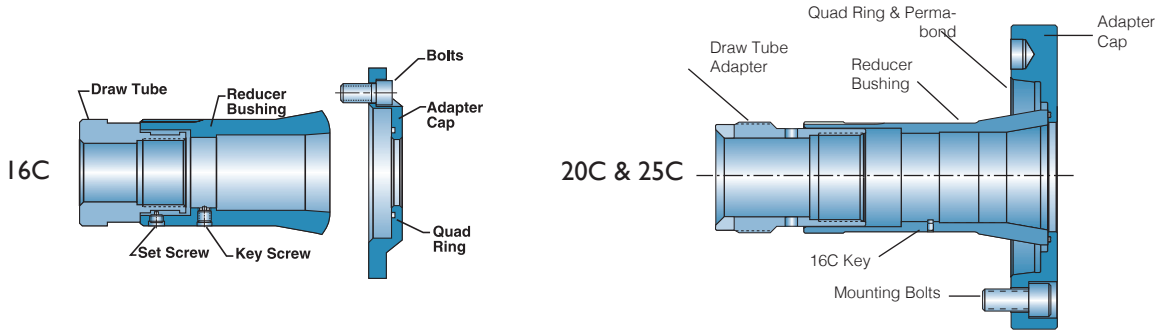

Spindle Collet Adapters

Description	A2-5 Spindle 16C to 5C Part Number	A2-6 Spindle 20C to 16C Part Number	A2-6 QUEST® 25C to 16C Part Number	A2-8 Spindle 25C to 16C Part Number
Adapter Assembly - includes:	16B-0000185-5C	7535-00-00	2993-00-00	7457-00-00
Draw Tube Adapter	16A-0000301-5C	7541-00-00	7463-00-00	7463-00-00
Reducer Bushing	16A-0000186-5C	7537-00-00	7461-00-00	7461-00-00
Bolts [3] (20C & 25C 4ea.)	CC-0007373	MS-0104219	MS-0104219	MS-0104620
Adapter Cap	16B-0010768	7543-00-00	7543-00-00	7459-00-00
Quad Ring	40-0011151-32	41-0011151-45	41-0011151-45	41-0011151-45
Key	—	7539-00-00	7465-00-00	7465-00-00
Key Screw	16-0000338-5C	—	—	—
Set Screw	N-0590304-L	—	—	—
PermaBond 910	QC-0010884	QC-0010884	QC-0010884	QC-0010884

NOTE: For use with collets, positive stops, master expanding collet and pads, collet fixture plates, stub/mill arbors, and spindle centers and drivers.

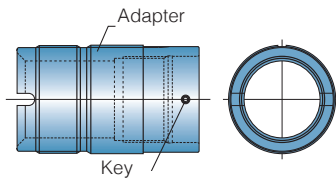

Spindle Step Chuck Adapters

Style	Description	Part Number
16C	N/A	
20C	20C to 16C Step Chuck Adapter - includes: Draw Tube Adapter Key	7911-00-00-000000 7913-00-00-000000 7915-00-00-000000
25C	N/A	

NOTE: Uses the lathe's standard closer with the adapted step chuck.

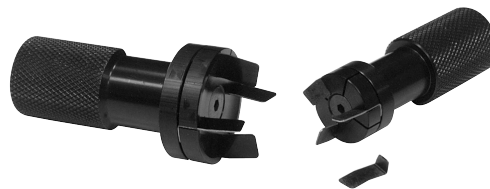

Collet Face Spanner Wrenches

Collet	Wrench Part Number	Replacement Finger Set Part Number
3J, 16C	7901-00-00-00003J	7901-00-00-00FNGR
5C	7899-00-00-000000	7899-00-00-00FNGR
20C	7901-00-00-00020C	7901-00-00-00FNGR
25C	7901-00-00-00025C	7901-00-00-00FNGR
S15	7901-00-00-000S15	7901-00-00-0015FN
S20	7901-00-00-000S20	7901-00-00-00SFNG
S26	7901-00-00-000S26	7901-00-00-00SFNG
S30	7901-00-00-000S30	7001-00-00-00SFNG

Fixture plates are used to mount parts which cannot be held in a collet, step chuck, expanding collet or jaw chuck. The clamping method is custom designed and manufactured by the customer to meet the machining requirements. Fixture plates normally have to be balanced to be safely run because the parts are not uniform or clamped in an off-center position. Collet and spindle-mount styles are available for both 5C and 16C spindles.

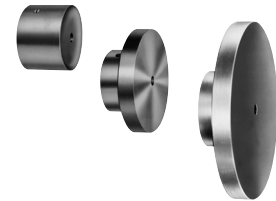

3 Sizes of 5C Fixture Plates

Spindle-Mounted and Collet-Style Fixture Plates

Description	Taper Part No.	Threaded Part No.	Taper Model	Threaded Model	A – Diameter	B – Flange
5C Fixture Plate	53A-0008750	53A-0008750-D	C-23	C-23D	3" (76.20)	—
5C Fixture Plate	55A-0008750	55A-0008750-D	C-24	C-24D	5" (127.00)	3/4" (19.05)
5C Fixture Plate	59A-0008750	59A-0008750-D	C-25	C-25D	8 7/8" (225.43)	3/4" (19.05)
16C Fixture Plate	A2-0008750-05			C-24A	5 1/2" (139.70)	—
A2-5 Fixture Plate	A2-0008750-08			C-25A	8 7/8" (225.43)	.750" (19.05)
5C Collet-Style	1397-00-00-000000			5C-3F	3 3/8" (85.73)	1" (25.40)
5C Collet-Style	1399-00-00-000000			5C-4F	4 3/8" (111.13)	1" (25.40)
16C Collet-Style	1785-00-00-000000			—	6.370" (161.79)	1" (25.40)

NOTE: Millimeters in parentheses.

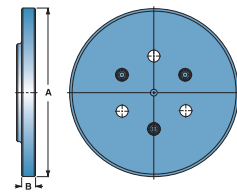

A2-5 Fixture Plate

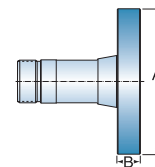

Collet Style Fixture Plates

Dead-Length Work Stops (Backing Plates) are used to hold extremely close lengths on parts that have a stem and a locating shoulder. The stem is gripped by the collet and the shoulder located against the stop plate. As the collet closes, it pulls the workpiece back against the backing plate. The workpiece length can be accurately controlled even when the gripping diameter of the part varies. The part is much more stable than one held in a collet against its face or a counterbore. This allows longer parts to be machined with better tool life. When running small quantities, the spindle mount does not have to be used. This system is the least costly of all precision length control systems.

5C Dead-Length Work Stops

Description	Taper Part Number	Threaded Part Number	Taper Model	Threaded Model
Spindle Mount	ST-0011203	ST-0011203-D	WS	WSD
Stop Plates [Set of 3]		ST-0011223		WSS



5C Spindle Mount & Stop Plates

16C Dead-Length Work Stop Assembly

Description	Part Number
Spindle Mount Assembly	1311-00-00-000000
Includes:	
Work Stop Spindle Mount	1313-00-00-000000
Flat Face Set Screw [4]	0570306
Mounting Bolt [4]	0101216
Work Stop Plates (Set of 3)	1315-00-00-000000

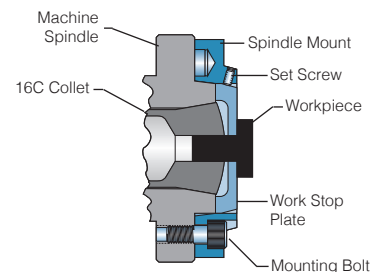

5C Face & Angle Plates

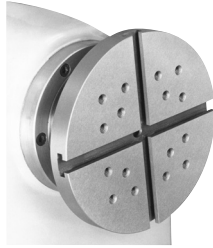

5C Face Plates	Taper Part Number	Threaded Part Number	Taper Model	Threaded Model	A – Diameter
Face Plate ¹ -5C	57A-0000692	57A-0000692-D	C-26	C-26D	7.000" (177.80)
Face Plate ¹ -5C	59A-0000692	59A-0000692-D	C-27	C-27D	8.875" (225.42)

Spanner for Face, Fixture & Driver Plates and Work Stops, 5/16" Pin Part No. 460-0009189

¹ – Drilled and tapped for 5/16" x 18 TPI bolts. **NOTE:** Millimeters in parentheses.

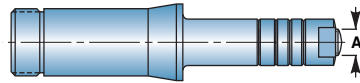
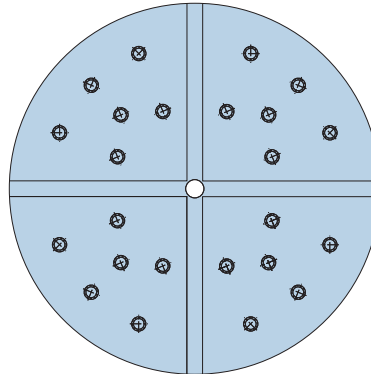
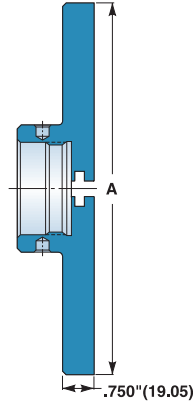

5C Stub/Mill Arbors

5C Stub Arbors are available in 5/8" and 1/2" shaft diameter. The stub arbors can be used on any mill with a 5C spindle. They are made for simple milling operations on Hardinge-style mills.

Description	Part Number	Model	A – Shaft Dia.
Stub/Mill Arbor	54-0002602	M-4	5/8" (15.88)
Stub/Mill Arbor	53-0002602	M-5	1/2" (12.70)
Center With Driver	U-0009186	M-1	
Drive Plate:			
Taper	57-0000298	G-12	N/A
Threaded	57-0000298-D	G-12D	N/A
Driving Dog	37-0002617	G-1	N/A

NOTE: Millimeters in parentheses.

5C Center with Driver

The Hardened, Precision-Machined center with the driver is required for between-center work on any machine or attachment with a 5C Spindle.

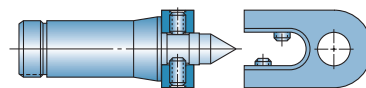

5C Driving Dog and Driver

The drive plate mounts on the Hardinge 5C spindle nose and is used in conjunction with the driving dog to drive work between centers. When ordering, specify for taper- or threaded-nose spindle.

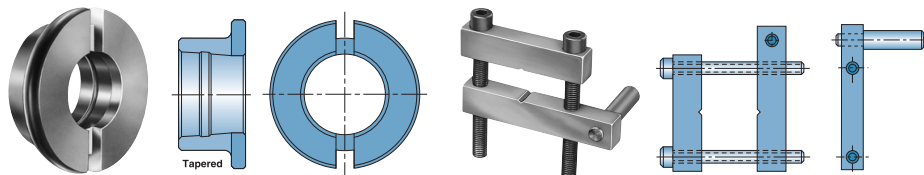

Custom manufacturing of Special Collets and Step Chucks

Hardinge will manufacture special 5C, 16C, 20C and 25C collets and step chucks to hold your extruded stock, non-round parts, eccentric, off-center and stepped parts. Special accuracy collets and step chucks, extremely deep and/or large diameter step chucks and closers are some of the frequently made items in our special collet department. If you have a special workholding application, Hardinge can manufacture a workholding device to accurately grip it.



Specials are manufactured to rigid specifications, including material, proper heat treat and machined accuracy. The experts in our engineering department can offer you technical assistance in designing your collet, step chuck or related workholding device for your special machining needs. Hardinge can manufacture many of your unusual or unique workholding items to your specifications. For generations, Hardinge specials have been the choice of experienced machinists, manufacturing engineers and productivity-oriented manufacturers.

To request a quote or to order a special workholding device, please call 800-843-8801, or fax your drawing to 607-737-0090. Specifications for the most common special collets are shown on the following two pages. These pages can be photocopied, filled out and faxed or mailed to the Hardinge Sales Department. When sample parts are being sent to Hardinge, please call for a Returned Material Authorization number to help speed up the process. The drawings and sample parts should be addressed to: Hardinge Inc., Collet Sales Department, One Hardinge Drive, Elmira, NY, 14902-1507.



Protect your 5C collet investment with Hardinge® **Collet Racks**. Store your collets in a manner that will protect the head angle, threads and keyway. The collet racks give quick access and easy collet selection and are designed to bolt to your work table for maximum stability. Available in a 35 capacity rack and a stepped 28 capacity rack. The stepped model holds fully assembled Dead-Length® collets, collets with stops, master expansion collets, standard and extra-depth step chucks.

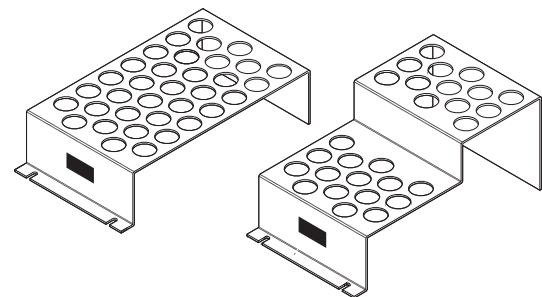

5C Collet Racks	Capacity	Part Number
5C Collet Rack	35	0944-00-00-000032
5C Collet Rack - Stepped	28	0944-00-00-000028

Custom Quote Request | of 3

To place your order or request a quote, simply fill out this form and send the requested information below. We want to make it easy as possible for you to get your quotation back, so checking the box in front of each item will help to ensure everything is complete before sending the information to us. The following two pages will assist you in choosing your collet configuration.

- Your Name _____
- Company _____
- Address _____
- City, State & Zip _____
- Phone _____
- Fax _____
- Machine Make and Model Number on which workholding will be used:**
(Example: Hardinge Quest 8/51)
- Collet Required:**
(Example: 20C)
- Spindle Nose:**
(Example: A2-6)
- Sample Stock** (6" long - extruded stock), casting, first operation part, finished part
- Legible Prints** of the stock, finished part. These must be marked to show the diameters or surfaces to be gripped. Mark the locating surface used for length control. Please mark the surfaces to be machined.
- AutoCad Files** or dxf files of the above, if available.
- Written Explanation** of any special requirements:
For example special concentricity or perpendicularity requirements, concerns with chip flushing, requirements for thru-spindle coolant, customer concerns with part being deformed by gripping, large variation of gripping surface or locating dimensions, etc.

Explanation:

— This page may be duplicated —

- Fill in the Type of Collet or Special (example 5C, 20C, 3J)
 - Find the illustration of the feature needed in one of the boxes
 - Put a Bold "X" in the box to indicate that feature
 - Write the required dimensions next to their numbers in the chart to the right
- Note: Only fill in the dimensions for the numbers on one illustration

Type of Collet or Special:
(example: 5C, 16C, #3J, etc.)

Numbers below correspond to dimensions in boxes

Today's Date _____
 Date Order Required _____
 Customer Number _____
 Purchase Order Number _____
 Method of Shipping _____

Bill To:
 Name _____
 Title/Dept. _____
 Company _____
 Address _____
 City, State, Zip _____
 Phone _____ Fax _____

Ship To: (If different from Bill To)
 Name _____
 Title/Dept. _____
 Company _____
 Address _____
 City, State, Zip _____
 Phone _____ Fax _____

- ① Order Hole Size: _____
- ② Order Hole, 2nd: _____
- ③ Number of Slots: _____
- ④ Radius: _____
- ⑤ Bearing Length: _____
- ⑥ Bearing Length Front: _____
- ⑦ Back Drill Dia.: _____
- ⑧ Relief Dia.: _____
- ⑨ Relief Length: _____
- ⑩ Depth of Step, 1st: _____
- ⑪ Depth of Step, 2nd.: _____
- ⑫ Auxiliary Hole Size: _____
- ⑬ Length of Extension: _____
- ⑭ Dia. at Face: _____
- ⑮ Degrees Taper/Chamfer: _____
- ⑯ Front Dimension of Taper: _____
- ⑰ Rear Dimension of Taper: _____
- ⑱ Taper-Industrial Std: _____
- ⑲ Off Center Distance: _____
- ⑳ Order Hole - Width: _____
- ㉑ Order Hole - Length: _____
- ㉒ Thread Length: _____
- ㉓ Threads Per Inch: _____
- ㉔ Right/Left Hand Thrd.: _____
- ㉕ Class Thread (1), (2), (3): _____
- ㉖ Chamfer Depth: _____
- ㉗ Inscribed Circle: _____
- ㉘ Circumscribed Circle: _____
- ㉙ Clearance Bore: _____
- ㉚ Actuator Stroke: _____

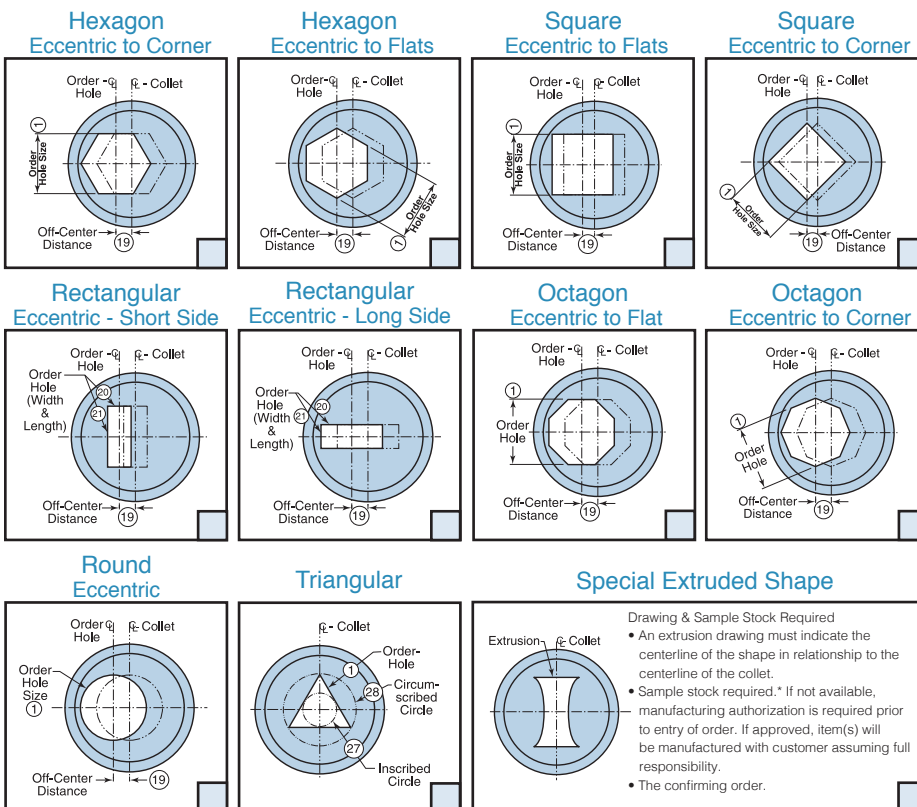

Send Drawings, Sample Parts
and this form to:

Hardinge Inc.

Collet Sales Dept.
One Hardinge Drive
Elmira, New York 14902-1507

Phone: 800-843-8801

Fax: 607-737-0090

Email: info@shophardinge.com

Canada: 800-468-5946

Drawing & Sample Stock Required

- An extrusion drawing must indicate the centerline of the shape in relationship to the centerline of the collet.
- Sample stock required. * If not available, manufacturing authorization is required prior to entry of order. If approved, item(s) will be manufactured with customer assuming full responsibility.
- The confirming order.

*One 6" length of stock required when ordering 1 to 3 collets; two 6" lengths for 4 to 7 collets; three 6" lengths for 8 to 11 collets; four 6" lengths for 12 to 15 collets ordered.

Custom Quote Request 3 of 3

Checkmark the box with the feature you require and record the dimensions on the corresponding lines 1-30 on the previous page.

Over-the Shoulder

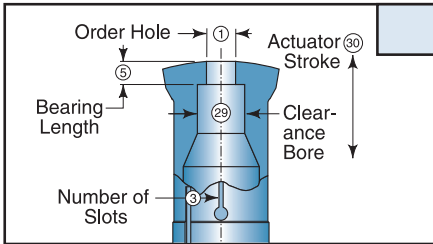

Flat Face

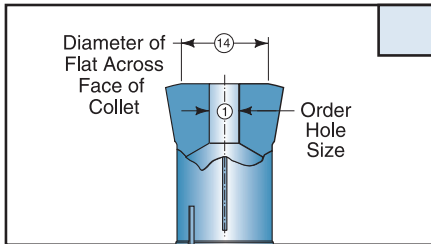

Bearing Relief

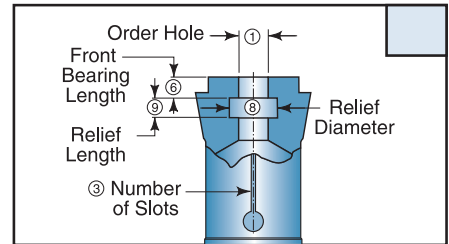

Chamfer - Depth

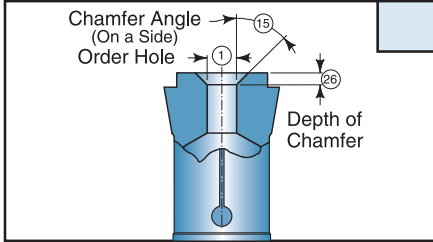

Chamfer - Diameter

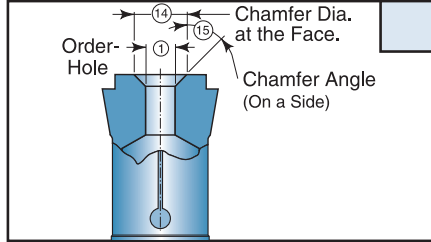

Radius

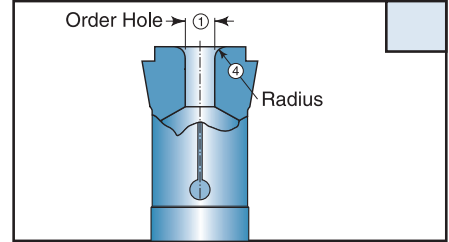

Special Bearing Length

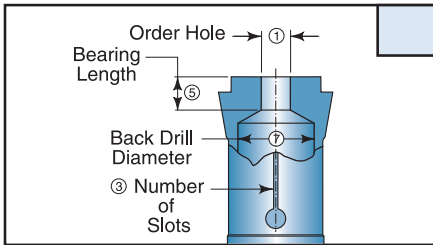

Eccentric Step - Aux. Off Center

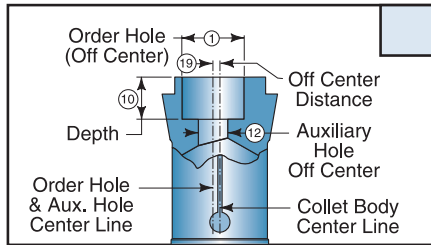

Eccentric Step - Aux. On Center

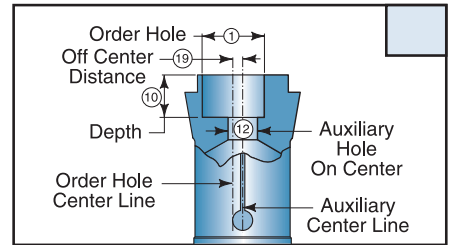

Single-Stepped

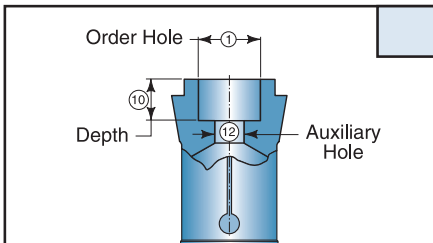

Double-Stepped

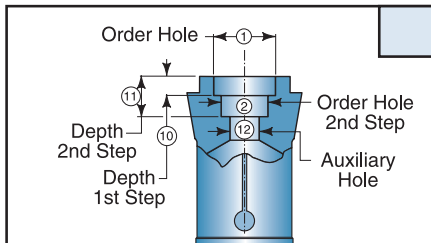

Threaded Order Hole

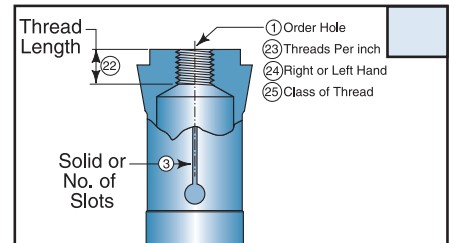

Extended Nose - Straight

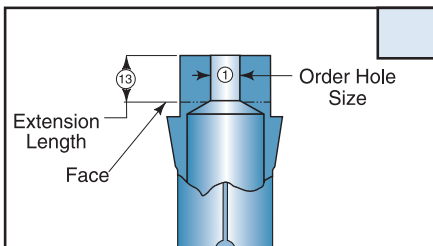

Extended Nose - Tapered

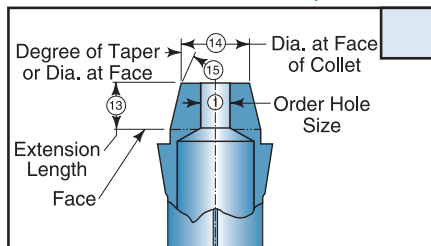

Angular Slotted

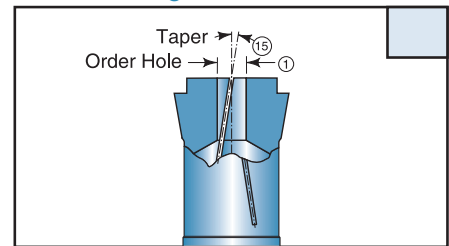

Taper - Regular

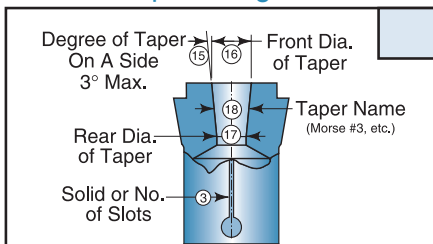

Taper - Reverse

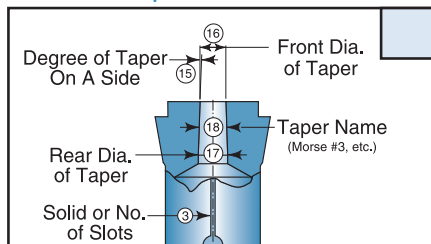

Zig-Zag Slots

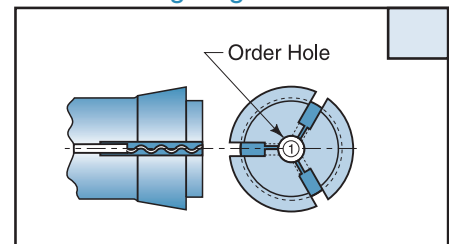

B65 Collet Chuck

The B65 collet chuck is a Dead-Length® system designed to provide very precise length control of the workpiece. This exact part-length feature makes it possible to accurately transfer parts from one spindle to the other within .0005" (.0127 mm). The system uses either B65 Solid or B65 Style S22 Master Collets and pads.

The B65 Stationary Collet is used on the Hardinge QUEST® TwinTurn® 65 CNC Turning Center and other machines that use B65 Stationary Collet Systems.

Stationary collet systems are noted for their length control feature. The collet does not move when it is closed. It is inserted into the collet chuck or spindle adapter and held in place with a cap. The collet is closed by a sleeve which moves forward on the collet closing angle. The B65 standard collet has RTV sealant in slots up to the Teflon chip sleeve and seal.



These units can be used for Dead-Length applications on lathes with A2-6 spindle noses. Separate link-ups will be needed for other lathes. Collet sold separately.

B65 Collet Chuck Assembly and Parts List

Item	Description	Qty	Part Number
	B65 Collet Chuck Assembly	1	3757-00-00-000000
1	Tool	1	3757-00-00-000009
2	Spring Plunger Reid # ST-4N	3	CE 0375711
3	Spring Plunger Reid # K2-N	1	CE 0375712
4	Key Screw	1	37570000000008
5	Key Pin	1	37570000000007
6	Retaining Screw	1	37570000000006
7	Cam	1	37570000000005
8	Spring-Spec. # C-0360-047-1000-M	1	CE 0360047100M
9	Lock Pin for Cam	1	37570000000004
10	Cap	1	37570000000002
11	M12 x 30 Socket Head Cap Screw	3	MS 0104220
12	B65 Mount	1	37570000000001
13	Collet Spring	1	CE 0375710
14	Collet Sleeve	1	37570000000003
15	1/8" Dia. x 5/16" Dowel Pin	1	0004628

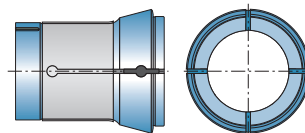
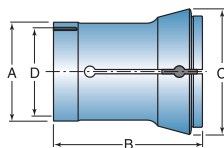
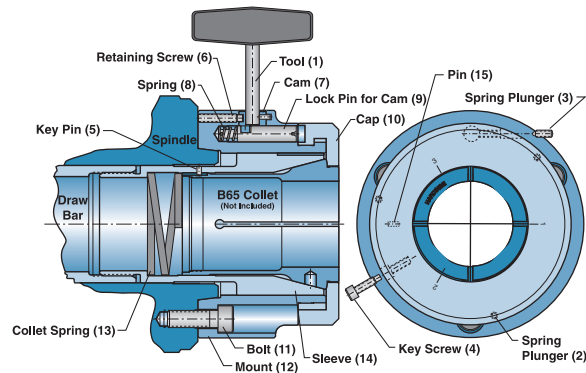

B65 Standard Collet

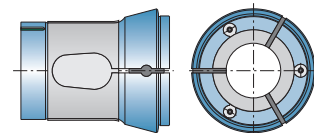

B65 Style-S Collet

Collet Dimensions

Collet Style	A – Back Bearing Dia.	B – Overall Length	Head Diameter	D – ID Stop Thread	Round Capacity	Hex Capacity	Square Capacity
Std.	2.832" (71.93)	4.328" (109.93)	3.603" (91.51)	M66 x 1	1/16" – 2.559"	1/16" – 2.216"	1/16" – 1.809"
S22	2.832" (71.93)	4.328" (109.93)	3.603" (91.51)	M66 x 1	1/8" – 2 1/4"	1/4" – 1 15/16"	1/4" – 1 37/64"

* No internal threads over 2.530" Round, 2.191" Hex, 1.789" Square

NOTE: Millimeters in parentheses.

B65 Collets – Standard and Style-S

Description	Round Smooth Part Number	Round Serrated Part Number	Hexagon Part Number	Square Part Number	Emergency Part Number
B65 Solid Collet	3743-00-19-	3743-00-59-	3743-00-29-	3743-00-39-	3743-14-10-
B65 S22 Master Collet	5311-00-00-	—	—	—	—
S22 Pads	5611-00-19-	5611-00-59-	5611-00-29-	5611-00-39-	5611-14-10-

NOTE: Other collet & pad configurations available.

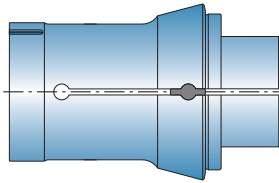

B65 Collets – Emergency Extended-Nose

Description	Part Number	Nose Length	Pin Part No. ($\frac{3}{16}$ " x 1")
B65 Ext. Nose Emergency Collet	3743-14-13-001875	1.5" from face	TL-0006648

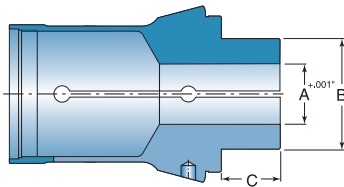

B65 Special Extended-Nose Hardened Precision Collets

Hardened, precision collets were designed for the times you require extended-nose collets due to tooling interference. The hardened precision collets are most economical for long run jobs.

Description	Part Number	A – Smooth or Serrated Bore	B – Nose Diameter C – Extension
B65 Ext. Nose Hardened Collet	93743-67-18-	$\frac{1}{8}$ " to $2\frac{3}{64}$ " (3.17 to 63.89)	determined by the customer, or Harding, to meet the specific workpiece requirements.

NOTE: Millimeters in parentheses.

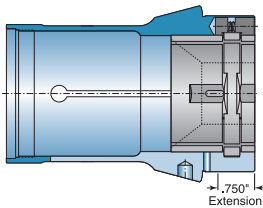

B65 Style S22 Extended-Nose Master Collet

The Style "S" Extended-Nose Master Collets are ideal when frequently changing bar stock diameters. Only the pads need to be changed from one bar size to another; much quicker than changing standard collets. The pads take up less storage space and are less expensive than standard collets.

Description	Part Number	Nose Diameter
B65 S22 Ext. Nose Master Collet	5311-54-00-000000	3.188" (80.97)

NOTE: Millimeters in parentheses.

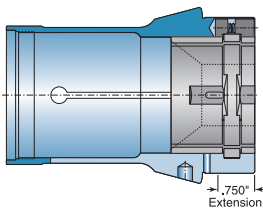

B65 Style S22 Extended-Nose Emergency Pads

The Special Style-S Extended-Nose Emergency Pads are specifically designed for the Extended-Nose S22 Master Collet. The back of the pad extends the full length of the master collet bore. This design ensures that the closing forces are directly over the collet pads. This is a special order product.

Description	Part Number	Nose Diameter
B65 S22 Ext. Nose Pads	95611-67-00-0769Q	$\frac{1}{8}$ " to $2\frac{1}{4}$ " (3.1 to 57.15)

NOTE: Millimeters in parentheses.

B65 Threaded Positive Solid Stops

The stop assembly is threaded into the back of the collet and can be machined to locate the part for accurate length control.

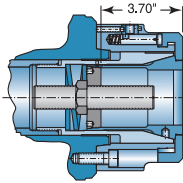

Description	Part Number
B65 Solid Stop Assembly - includes:	3759-00-00-000000
Body	3759-00-00-000001
Nut	1185-00-00-000000
Threaded Stop (1" diameter screw)	1363-00-00-000000

NOTE: The stop can be installed in all solid and master collets internally threaded with bores up to: 2.530" (64.2mm) Round; 2.191" (55.6mm) Hex; 1.789" (45.4mm) Square.

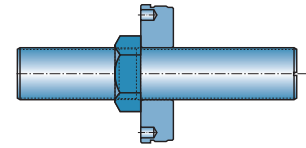

B65 Guide Bushing

The Guide Bushing is used to guide and support the bar stock into the bore of the collet when changing bars. The hole in the bushing should be $\frac{1}{32}$ " (.79mm) larger than the bar stock. The hole is bored to size by the customer. (Part Number 3761-00-00-000000)

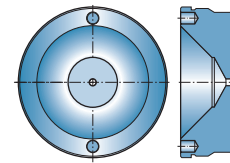
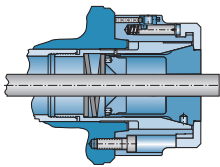

B65 (Internal) Chip Shield Kits

The shield reduces the possibility of chips going through the slots of the collet when through drilling or boring second operation work. The threaded stop or guide bushing cannot be used with the shield.

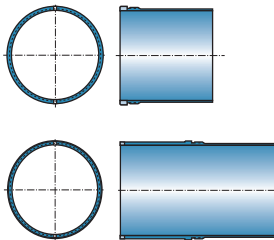

Description	Part Number
Short Sleeve Kit - includes:	3757-00-00-000010
Shield	3757-00-00-000011
Wrench	3757-00-00-000012
Long Coolant Nozzle	3757-00-00-000015
Long Sleeve Kit - includes:	3757-00-00-000013
Shield	3757-00-00-000014
Wrench	3757-00-00-000012
Short Coolant Nozzle	3757-00-00-000016

NOTE: The chip shield can be installed in all solid and master collets below 2.43" (61.7mm) round.

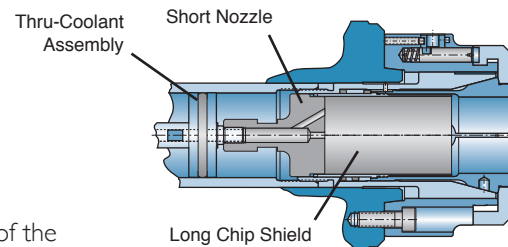
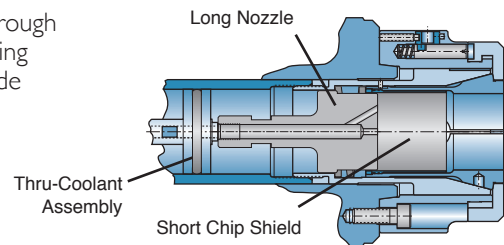

B65 Coolant Nozzles

The Coolant Nozzles are threaded onto the end of the thru-spindle coolant assembly before the unit is inserted into the draw tube. The short nozzle is for the long chip shield and the long nozzle is for the short chip shield.

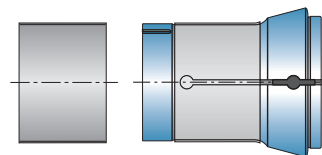
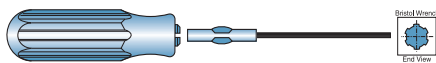

B65 Accessories

Description	Part Number
Bristol Wrench Handle	7909-00-00-000013
Wrench .145"	7909-00-00-000002
Seal - Standard Collet (12)	7649-00-00-010000
Seal - Style "S" (by dozen)	7643-00-00-010000
Clamp Asm. 1 ea. (3 Req.)	7627-00-00-000000
Bristol "L" Wrench	7639-00-00-000000
RTV Sealant (for slots)	CE-0010884-0832
Teflon Sleeve	3757-00-00-0000A19

An external Heat-Shrinkable **Teflon Sleeve** is standard on all B65 collets with the straight slots which have a relief hole at the end. Older collets with the tear-drop slot may not have the sleeve. Its purpose is to help keep chips from getting into the collet chuck assembly. The Teflon sleeve can easily be replaced if it becomes damaged. It can also be added to older B65 collets. The slots are sealed up to the sleeve with RTV Sealant (Dow Corning #832).

TT65 / LMC to B42 Collet System

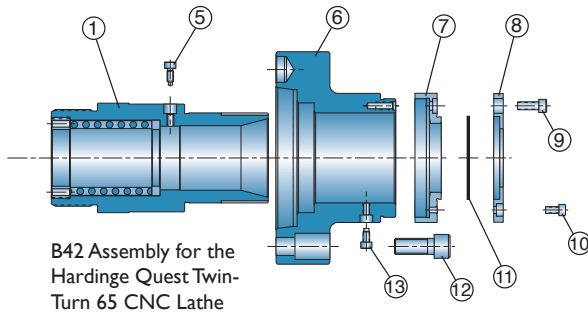

B42 Assembly for the Hardinge Quest Twin-Turn 65 CNC Lathe

Coolant Nozzle

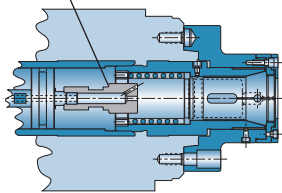

The B42 Coolant Nozzle is threaded onto the end of the through-spindle coolant assembly before the unit is inserted into the draw tube. Coolant nozzle included. Part Number 3111-00-00-000011.

The **B42 Stationary Collet Adapter Assembly** is a Dead-Length® system designed to provide precise length control of the workpiece. This feature makes it possible to accurately transfer parts from one spindle to the other within .0005" (.0127 mm). The system uses either B42 Solid or B42 Style S10 Master Collets and pads. The B42 Stationary Collet can be used on the Hardinge machines indicated below as well as other machines with an A2-6 spindle nose. Separate linkups will be required.

Adapter Assembly and Parts List for the Hardinge® Quest® TwinTurn® 65

Item	Description	Qty	Part Number
—	B42 Collet Adapter Assembly	1	3719-00-00-000001
1	Spring Assembly (Items 1-4 in previous catalog—do not disassemble)	1	3719-00-00-000015
5	— Removable Keyscrew	1	3111-00-00-000007
6	— Mount	1	3719-00-00-000002
7	— Cap	1	3719-00-00-000003
8	— Cover	1	3719-00-00-000005
9	— M6 x 16 SHCS	4	MS 0103617
10	— M5 x 10 SHCS	4	MS 0103515
11	— Seal	6	3719-00-00-000006
12	— M12 x 30 SHCS	4	MS 0104019
13	— Keyscrew	1	3111-00-00-000008
14	— Plug	6	3075-00-00-000004
15	— Coolant Nozzle	1	3111-00-00-000011
16	— Teflon Sleeve	3	3719-00-00-000012

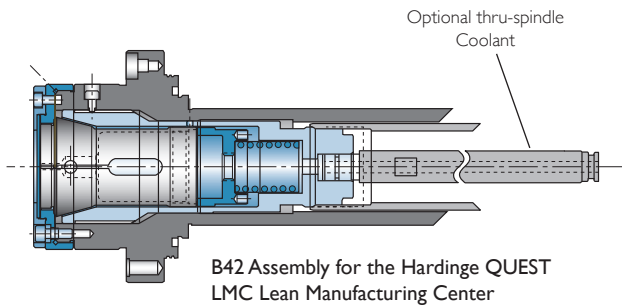

B42 Assembly for the Hardinge QUEST LMC Lean Manufacturing Center

B42 extended-nose collets, expanding collets, ejector stops, chip control and thru-spindle coolant are available per application.

B42 Adapter Assembly and Parts List for the QUEST® LMC42 Lean Manufacturing Cell

Item	Description	Qty	Part Number
—	B42 Collet Adapter Assembly	1	3719-00-00-000024
1	— Collet Sleeve	1	3719-00-00-000025
2	— Collet Sleeve Spring	1	CE-1250156-1750
3	— Spring Retainer	1	3719-00-00-000026
4	— Cap	1	3719-00-00-000003
5	— Plug	6	3075-00-00-000004
6	— Seal	1	3719-00-00-000006
7	— Cover	1	3719-00-00-000005
8	— M6 x 16 SHCS	4	MS 0103617
9	— M5 x 10 SHCS	4	MS 0103515
10	— Teflon Sleeve	3	3719-00-00-000012
11	— Instructions	1	B -0009500-0121

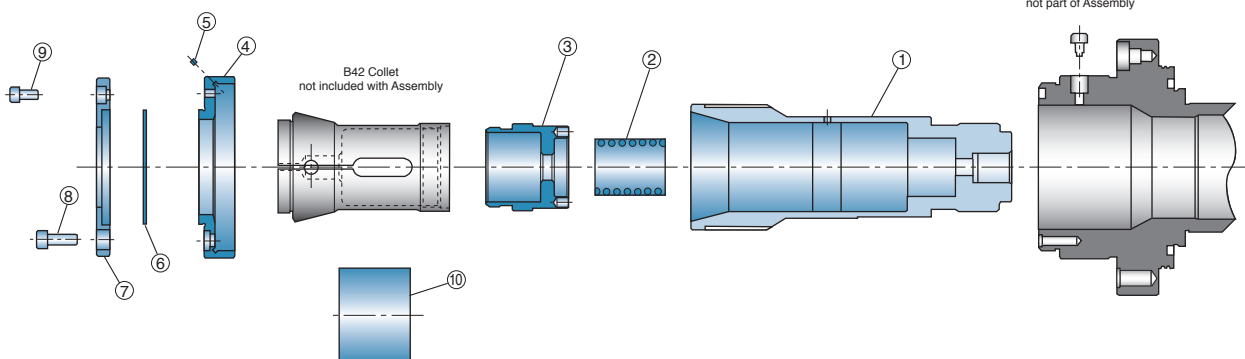

Machine Spindle & Key Screw
not part of Assembly

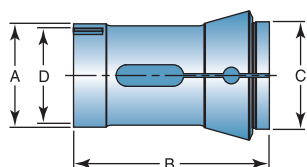

Dimensions

Collet Style	A – Back Bearing Diameter	B – Overall Length	C – Head Diameter	D – ID Stop Thread	Round Capacity	Hex Capacity	Square Capacity
Std.	1.887" (47.93)	3.688" (93.68)	2.355" (59.82)	M43 x 1	1/16"(1.58) – 1 5/8" (41.28)	1/16"(1.58) – 1 13/32" (35.72)	1/16"(1.58) – 1 1/4" (28.97)
S10	1.887" (47.93)	3.688" (93.68)	2.355" (59.82)	M43 x 1	1/8"(3.17) – 1" (25.40)	1/4"(6.35) – 55/64" (21.83)	1/4"(6.35) – 45/64" (17.86)

NOTE: Millimeters in parentheses.

B42 Collets – Standard and S10 Master Collets and Pads

Description	Round Smooth Part Number	Round Serrated Part Number	Hexagon Part Number	Square Part Number	Emergency Part Number
B42 Solid Collet	3719-00-19-	3719-00-59-	3719-00-29-	3719-00-39-	3719-14-10-
B42 S10 Master Collet	5205-00-00-	—	—	—	—
S10 Pads	5601-00-19-	5601-00-59-	5601-00-29-	5601-00-39-	5601-14-10-

NOTE: Other configuration collets & pads available.

B42 Emergency Collets—Standard and Extended-Nose

Even with the best planning, emergencies arise when your tool room and production departments require a stepped, odd size or special-shaped collet. On such occasions, use the Hardinge emergency collet. The soft face and pilot hole allow rapid drilling, boring or stepping out to the exact required size. The extended-nose allows deeper counter bores, when required, and tool clearance for extended work. Emergency collets have internal threads for positive stops.

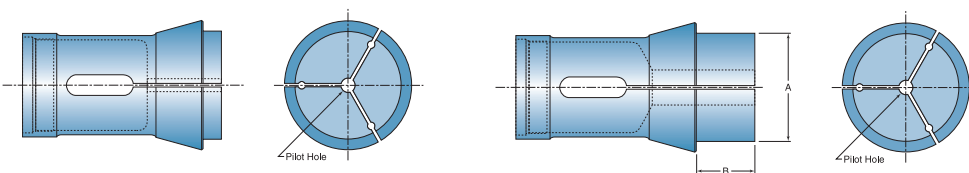

Description	Part Number	Pilot Hole	A – Nose Diameter	B – Nose Length
B42 Emergency Collet	3719-14-11-000000	.250" (6.35)	1.970" (50.00)	.375" (9.53)
B42 Extended-Nose Emergency Collet	3719-14-11-000007	.250" (6.35)	1.970" (50.00) (Standard)	1.250" (31.75) (.875" over standard)

NOTE: Millimeters in parentheses.

TT65 to #22 B&S Collet System



The **#22 B&S Dead-Length Collet Chuck System** will provide minimal tool interference while achieving shorter cycle times when your work is under 1 1/4" diameter.

The nose diameter is just 3.5" by 2.3" (88.9 x 58.4mm) long with an overall chuck length of 3.783" (96mm) from the spindle locating surface. This stationary collet design provides precise length control of the workpiece. The Dead-Length feature makes it possible to accurately transfer parts from one spindle to the other within .0005" (.0127mm). The system uses either #22, #22Y or #22SC B&S collets.

The #22 B&S Stationary Collet is used on the Hardinge QUEST® TwinTurn® 65 CNC Turning Center and other machines that use #22 B&S Stationary Collet Systems.

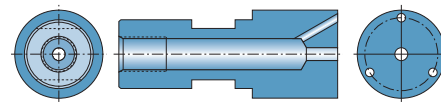
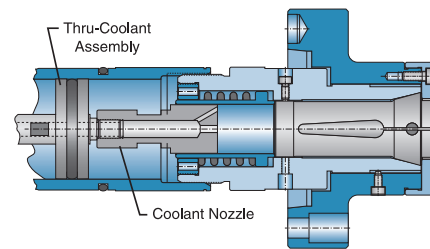
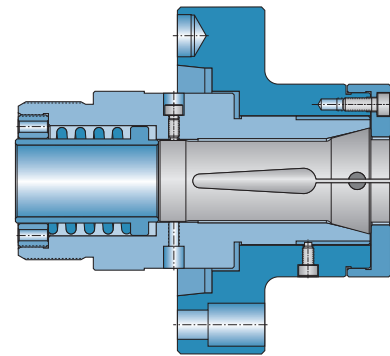

The **#22 B&S Coolant Nozzle** is threaded onto the end of the through-spindle coolant assembly before the unit is inserted into the draw tube. A coolant nozzle is included with each assembly. Part Number 3111-00-00-000011.

TT65 to #22 B&S Collet Assembly and Parts List

Item	Part Number	Qty	Description
—	3111-00-00-000001	1	TT65 to #22 B&S Collet Assembly
1	3111-00-00-000015	1	— Spring and Sleeve Assembly (Items 1-4 in previous catalog—do not disassemble)
5	3111-00-00-000007	1	— Removable Keyscrew
6	3111-00-00-000002	1	— Mount
7	3111-00-00-000003	1	— Cap
8	3111-00-00-000005	1	— Cover
9	MS 0103617	4	— M6 x 16 SHCS
10	MS 0103515	4	— M5 x 10 SHCS
11	3111-00-00-000006	6	— Seal
12	MS 0104019	4	— M12 x 30 SHCS
13	3111-00-00-000008	1	— Keyscrew
14	3075-00-00-000004	6	— Plug
15	3111-00-00-000011	1	— Coolant Nozzle
16	3111-00-00-000012	3	— Teflon Sleeve

NOTE: Keyed collets are not standard.

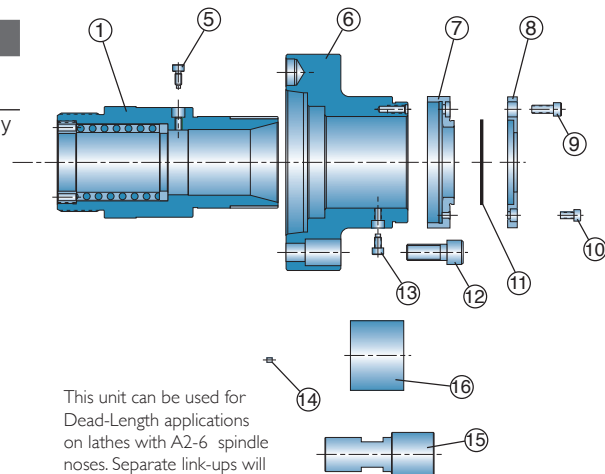

This unit can be used for Dead-Length applications on lathes with A2-6 spindle noses. Separate link-ups will be needed for other lathes. Collet not included.

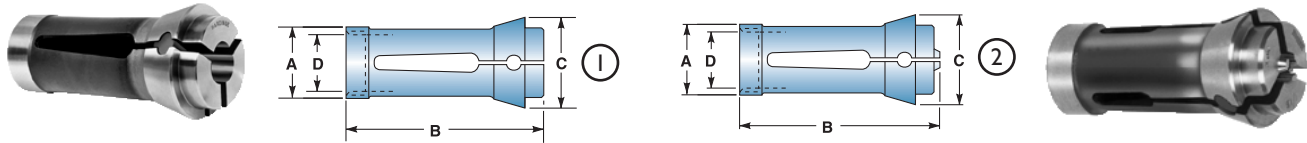

The **#22 B&S Stationary Collet** is used on the Hardinge QUEST® TwinTurn® 65 CNC Turning Center and other machines that use #22 B&S Stationary Collet Systems.

Dimensions

Description	Part Number	Figure	Style	A – Back Bearing Diameter	B – Overall Length	C – Collet Head Diameter	D - Thread	Round Capacity	Hexagon Capacity	Square Capacity
Collet, Solid	3111	1	22	1.498" (38.05)	4.250" (107.95)	1.925" (48.90)	—	1¼" (31.75)	1⅝" (27.38)	⅞" (22.22)
Collet, Solid	3109	2	22Y	1.498" (38.05)	4.312" (109.53)	1.925" (48.90)	—	.092" (2.33)	⅝" (1.98)	⅛" (1.58)
Collet, Solid	3227	1	22SC	1.498" (38.05)	4.250" (107.95)	1.925" (48.90)	1.291" x 24 RH	1¼" (31.75)	1⅝" (27.38)	⅞" (22.22)

Stop Collet

NOTE: Millimeters in parentheses.

#22 B&S Collets – Standard and Stop Collets

Description	Round Smooth Part Number	Round Serrated Part Number	Hexagon Part Number	Square Part Number
#22 B&S Standard	3111-00-19-	3111-00-59-	3111-00-29-	3111-00-39-
#22Y B&S Standard	3109-00-19-	3109-00-59-	3109-00-29-	3109-00-39-
#22SC B&S Stop	3227-00-19-	3227-00-59-	3227-00-29-	3227-00-39-

NOTE: Other configuration collets also available.

#22 B&S Emergency Collets

Emergency	Part Number	Pilot Hole
#22 Collet Blank	3111-10-00	—
#22SC-E	3233-14-10-	¼"
#22SC-E1	3233-12-10-	⅛"
#22SC-E2	3233-13-10-	⅛"

SS22 Solid Collet Stop for #22SC B&S Collet

The solid stop assembly is threaded into the back of the #22 B&S collet and the stop rod can be machined to length to locate the part. Collet sold separately.

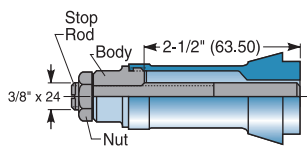

Description	Part Number
Assembly	3269-00-00-000000
– Body	3271-00-00-000000
– Nut	5-0001466-B
– Stop Rod	1071-00-00-000000

SE Ejector Stop for #22SC B&S Collets

The threaded ejector stop assembly is threaded into the back of the collet. The insert can be machined to locate the part. Collet sold separately.

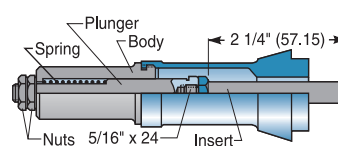

Description	Part Number
Assembly	3273-00-00-000000
– Body	3275-00-00-000000
– Plunger	3277-00-00-000000
– Insert	3279-00-00-000000
– Nut (2)	5-0001466-B
– Spring	3281-00-00-000000

16C to #22 B&S Collet System



These units can be used for Dead-
Length applications on lathes with
A2-5 spindle noses. Separate link-ups
will be needed for other lathes.

#22 B&S Collets sold separately on
previous page.

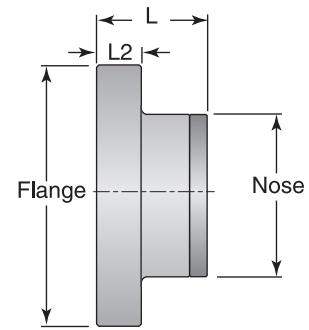

A2-5 16C Spindle to #22 B&S Collet Adaptation Chuck

Description	Assembly Part Number	Spindle	L – Length	L2 – Length	Flange OD	Nose OD	Thru Capacity
A2-5 16C to #22 B&S	1717-09-00-000000	A2-5	2.285" (58.04)	.915" (23.24)	5.500" (139.7)	3.400" (86.36)	1.25" (31.75)

NOTE: Millimeters in parentheses.

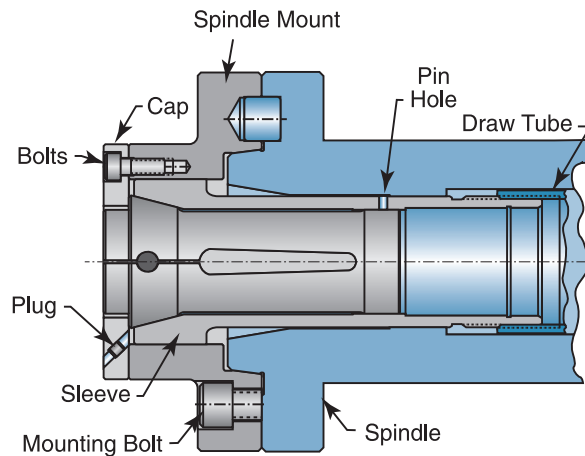

Parts List

Description	Qty	Part Number
Sleeve	1	1717-09-00-000003
Mount	1	1717-09-00-000001
Cap	1	1717-09-00-000002
Bolts for Cap – M6 x 16	4	MS 0103617
Mounting Bolts – M10 x 25	3	MS 0104019
Slinger Hole Plug	6	1717-09-00-000004
Orientation Pin 1/8" Dia. (Option)	1	3757-00-00-000007

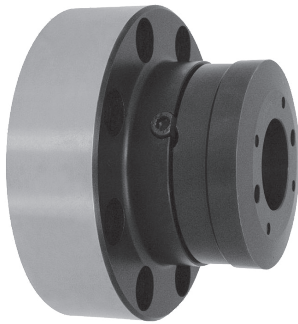

Not exactly as shown. See drawing for stepped nose design.

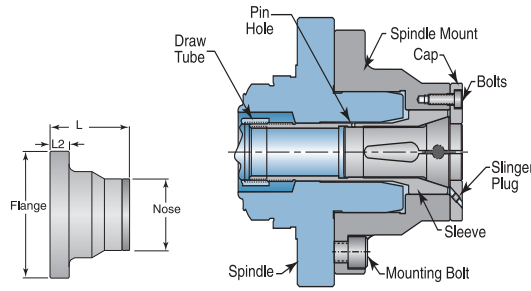

Assembly Parts List

Description	Qty	Part Number
- Sleeve	1	3075-00-00-000003
- Mount	1	3075-00-00-000001
- Cap	1	3075-00-00-000002
- Bolts for Cap, M5 x 16	4	MS 0103517
- Mounting Bolts, M10 x 25	3	MS 0104019
- Slinger Hole Plug	6	3075-00-00-000004
- Orientation Pin (Option)	1	- 3/32" Diameter Pin

GT 5C to #1 | B&S Collet Adaptation Chuck

Description	Assembly Part Number	Spindle	L - Length	L2 - Length	Flange OD	Step OD	Nose OD	Thru Capacity
GT 5C	3075-00-00-000000	GT	2.820" (71.62)	.76" (19.30)	5.000" (127.00)	3.400" (86.36)	2.830" (71.88)	5/64" (21.82)

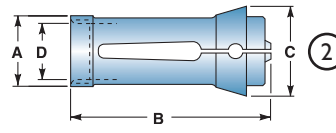
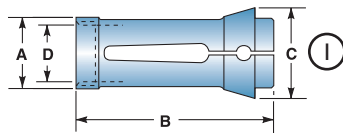

NOTE: Millimeters in parentheses.



#1 | B&S Collet Dimensions

Description	Part Number	Figure	Style	A - Back Bearing Diameter	B - Overall Length	C - Collet Head Diameter	D - Thread	Round Capacity	Hexagon Capacity	Square Capacity
Collet, Solid	3057	1	11	1.061" (26.95)	2.875" (73.03)	1.490" (37.85)	—	7/8" (22.22)	3/4" (19.05)	5/8" (15.87)
Collet, Solid	3055	2	11Y	1.061" (26.95)	2.937" (74.60)	1.490" (37.85)	—	55/64" (21.83)	3/4" (19.05)	39/64" (11.11)
Collet, Solid	3217	1	11SC	1.061" (26.95)	2.875" (73.03)	1.490" (37.85)	.916" x 24 RH	55/64" (21.83)	47/64" (18.65)	19/32" (15.08)
Stop Collet										
Collet, Solid	MP3591	2	11SCY	1.061" (26.95)	2.937" (74.60)	1.490" (37.85)	.916" x 24 RH	55/64" (21.83)	47/64" (18.65)	19/32" (15.08)

Stop Collet (Special Collet)

NOTE: Millimeters in parentheses.. Special Collets are not stock items.

#1 | B&S Collets – Standard and Stop Collets

Description	Round Smooth Part Number	Round Serrated Part Number	Hexagon Part Number	Square Part Number
#11 Solid Collet	3057-00-19-	3057-00-59-	3057-00-29-	3057-00-39-
#11Y Solid Collet	3055-00-19-	3055-00-59-	3055-00-29-	3055-00-39-
#11SC Stop Collet	3217-00-19-	3217-00-59-	3217-00-29-	3217-00-39-

SSI | Solid Collet Stop for #1 | SC B&S Collets

The solid stop assembly is threaded into the back of the #1 | B&S collet and the stop rod can be machined to length to locate the part. Collets sold separately.

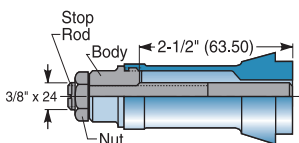

Description	Part Number
Assembly	3259-00-00-000000
- Body	3261-00-00-000000
- Nut	U-0004141-C
- Stop Rod	3263-00-00-000000

SEI | Ejector Stop for #1 | SC B&S Collets

The threaded ejector stop assembly is threaded into the back of the collet. The insert can be machined to locate the part. Collets sold separately.

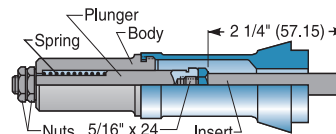

Description	Part Number
Assembly	3265-00-00-000000
- Body	3267-00-00-000000
- Plunger	1061-00-00-000000
- Insert	1063-00-00-000000
- Spring	1065-00-00-000000
- Nuts (2)	U-0004141-C

Manual Jaw Chucks

2, 3, and 4-jaw Chucks are available for manual machines with Hardinge® 5C Spindles. Products shown with bold part numbers are included with the chuck. Manual Chucks are also available with A2-4 and A2-5 mounting plates where indicated below.

Hardinge and other CNC lathes use Sure-Grip® 3-Jaw Power Chucks. Information for Sure-Grip chucks, along with full line of jaws for all chucks, can be found in Hardinge brochure number 2357 (chucks) and 2358 (jaws).



①

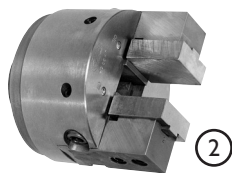

②



③



④

Description	Figure	Chuck	Soft Jaw	OD Jaw	ID Jaw	Reversible Hard Jaw	Wrench
5" 3-Jaw Universal							
Taper-Nose Spindle	2	53B-5405-HB	53B-5405-SJ	—	—	53B-5405-HJ	53B-5405-CK
Threaded-Nose Spindle	2	53B-5405-HB D	53B-5405-SJ	—	—	53B-5405-HJ	53B-5405-CK
with A2-4 Mounting Plate	4	53B-5405-BCA4	53B-5405-SJ	—	—	53B-5405-HJ	53B-5405-CK
with A2-5 Mounting Plate	4	53B-5405-BCA5	53B-5405-SJ	—	—	53B-5405-HJ	53B-5405-CK
5" 4-Jaw Independent							
Taper-Nose Spindle	2	54B-5405-HB	—	—	—	54B-5405-SJR	54B-5405-CK
Threaded-Nose Spindle	2	54B-5405-HB D	—	—	—	54B-5405-SJR	54B-5405-CK
6" 2-Jaw Universal (Jaws not included)							
Taper-Nose Spindle	3	62-5405-HB	62-5405-SJ	—	—	—	62-5405-CK
Threaded-Nose Spindle	3	62-5405-HB D	62-5405-SJ	—	—	—	62-5405-CK
6" 3-Jaw Universal							
Taper-Nose Spindle	2	63B-5405-HB	63B-5405-SJ	—	—	63B-5405-HJ	63B-5405-CK
Threaded-Nose Spindle	2	63B-5405-HB D	63B-5405-SJ	—	—	63B-5405-HJ	63B-5405-CK
with A2-4 Mounting Plate	4	63B-5405-BCA4	63B-5405-SJ	—	—	63B-5405-HJ	63B-5405-CK
with A2-5 Mounting Plate	4	63B-5405-BCA5	63B-5405-SJ	—	—	63B-5405-HJ	63B-5405-CK
6" 4-Jaw Independent							
Taper-Nose Spindle	2	64B-5405-HB	64B-5405-STJ	—	—	64B-5405-HTJ	64B-5405-CK
Threaded-Nose Spindle	2	64B-5405-HB D	64B-5405-STJ	—	—	64B-5405-HTJ	64B-5405-CK
with A2-4 Mounting Plate	4	64B-5405-BCA4	64B-5405-STJ	—	—	64B-5405-HTJ	64B-5405-CK
with A2-5 Mounting Plate	4	64B-5405-BCA5	64B-5405-STJ	—	—	64B-5405-HTJ	64B-5405-CK
8" 3-Jaw Independent							
with A2-5 Spindle Mount	4	83-5405-A25	—	—	—	83-5405-HRJ	83-5405-KEY
10" 3-Jaw Independent							
with A2-5 Spindle Mount	4	13-5405-A25	—	—	—	13-5405-HRJ	13-5405-KEY

Safety Information for 5C Spindle Tooling - Read Carefully

RECOMMENDATIONS FOR SAFE OPERATING CONDITIONS FOR HARDINGE 5C CAST IRON SPINDLE TOOLING

NOTE: All tooling is assumed NOT to be weakened by usage and to be free of defects.

SPINDLE TOOLING	SPEED	DRAWBAR FORCE
2", 3" & 4" Step Chuck Closers	Less than 5000 rpm	Less than 5000 lb force
5" and 6" Step Chuck Closers	Less than 4000 rpm	Less than 5000 lb force

FACE PLATES AND FIXTURE PLATES

The maximum surface speed of 6000 fpm includes allowances made for load eccentricities, clamping forces and stress concentrations. Operator discretion is needed because precise guidelines cannot be established due to the uncertainties in operating conditions. Following is a rough guideline. All rpm recommendations listed below result in surface speeds of less than 6000 fpm.

SPINDLE TOOLING	SPEED
3" Fixture Plates	Less than 3500 rpm
5" Fixture Plates	Less than 3000 rpm
8.875" Fixture Plates	Less than 2000 rpm
5" Jaw Chuck	Less than 3000 rpm
6" Jaw Chuck	Less than 2500 rpm
7" Face Plate with angle plate	Less than 2500 rpm
9" Face Plate with angle plate	Less than 2000 rpm

Manufacturer of Machine or Fixture	Collet	Page
All Tool	4C, 5C	43
American	3H, 6H	42, 43
Ames	1AM, 3AM	42
Armor	2M	42
Arrow	1A, 3AT, 3C, 5C	42, 43
Arter	5C	43
Atlas	3AT	42
Axelsson	Requires Sjogren Chuck	—
B&S Holders 156, 158, 160	1K	42
B&S Holders 246, 256	1K	42
Barker	1A, 3C	42
Barrett	Requires Sjogren Chuck	—
Becker	2AB, 2B, 3B	42
Benchmaster	2M	42
Boye & Emmes	6H, 8H	43, 44
Bradford	5NS	43
Bridgeport	2M, 7 B & S, B3, R8	42, 44, 45
Brown & Sharpe	7B, 9B	44
Burke	3C, 9B	42, 44
Carroll	4NS, 4C, 5C, 115	43, 45
Carroll & Jamieson	3H, 5C	42, 43
Carter & Hakes	4OS	43
Cataract	See Hardinge.	42, 43, 44
Chard	Requires Sjogren Chuck	—
Cincinnati	1AM, 3H, 6H, 8H	42, 43, 44
Clausing	3C, 5C	42, 43
Colborne	5C	43
Crownshield-Harris	2AB	42
Crystal Lake	3C, 4C, 5C	42, 43
Cushman, 1½" capacity	115	45
Cushman, 1¾" capacity	215	45
Cushman, 3¼" capacity	315	45
Dalton	3C, 4C	42, 43
Dandy	5C	43
Davis	2H, 3H, 6H	42, 43
Delta	5C, R8	43, 45
Diamond	7B, 9B	44
Dykrex	3C, 5C	42, 43
Elgin	2AB, 3C, 4C, 5C	42, 43
Ellis	3C	42
Fay & Scott	5NS	43
Flather	3C, 4NS, 4OS, 5NS	42, 43
Fray	2M, 7B	42, 43
Glenbard	5C	43
Gorton	4NS, 9B, GTM, R8	43, 44, 45
Graham	Requires Sjogren Chuck	—
Greaves-Klusman	3H	42
Hamilton	2B, 4C, 5C	42, 43
Hancock	5C	43
Hardinge®	1C, 2VB, 3C, 4C,	42, 43
Hardinge®	5C, 16C, 20C, 25C	43, 44
Hartford	Requires Sjogren Chuck	—
Heald	9B	44
Hendey	2H, 3H, 6H, 8H	42, 43, 44
Holland	7B	44
Hydromat	25W, 25W OS & Step, B32 & Step	44, 45
Hydromat	B32/45 & Step, B45 & Step, Pro-20 & Step	45
Index	3C, 9B	42, 44
Jacobs	JC	45
Jefferson	7B	44
Johansson	2M, 7B	42, 44
Jones & Lamson	J & L Center Mill	45
Kearney & Trecker Hldr 9026	1K	42
Kearney & Trecker Hldr 9027	1K	42
Knight	1K	42
L-W	4C, 4NS	43
LeBlond	3C, 4C, 4NS, 6L, 10L	42, 43, 44
Lee	5C	43
Lehmann-Brandes	5NS, 8WN	43, 44
Linley	LB	45
Lodge & Shipley	3H	42
Logan	3AT, 3C, 5C	42, 43
Majestic	4NS	43
Master	5C	43
Mead	3C, 5C	42, 43
Millmaster	9B	44
Monarch	2H, 3H, 5C, 5M, 6H	42, 43
Mueller	6H	43
Nebel	6H, 8H	43, 44
Nichols	4NS	43
Oliver Ace	1AM, 5C, 8H	42, 43, 44
Pacific	R8	45

Manufacturer of Machine or Fixture	Collet	Page
Pearson	R8	45
Porter-Cable	2H, 5C	42, 43
Potter	4C	43
Pratt & Whitney	3PN, 4PN, 5PN, 5P, 7P, 10P	42, 43, 44
Rahn-Larmon	6H, 8H	43, 44
Reed-Prentice	2VB, 6L	42, 43
Rivett	2NS, 2OS, 3NS, 4NS, 4OS	42, 43
Rivett	4S, 5C, 5NS, 5OS, 6NS, 6R	43
Rocheleau	5C	43
Rockford	2H, 3H	42
Rotex	9B	44
Rouse	4C, 4PN	43
Royal Oak	RO	45
Rusnok	9B	44
Schaublin	20W, 25W, 25W Stepped	44
Schauer	3C, 5C	42, 43
Sebastian	2J, 2S, 3H, 5C, 6H	42, 43
Seneca	2S, 3S	42
Seneca Falls	RO, 5C	43, 45
Sheldon	4C, 5C	43
Sidney	6H, 8H	43, 44
Sjogren, 1½" capacity	1J, 5C	42, 43
Sjogren, 1¾" capacity	2J	42
Sjogren, 1¾" capacity	3J	43
Sjogren, 2¼" capacity	22J	44
Sjogren, 3½" capacity	35J	44
Sloan & Chace	5SC, 52SC	43, 45
South Bend	1A, 2A, 2S, 3C, 4C	42, 45
South Bend	4NS, 5C, 5NS, 6H, 6K	43
Springfield	3H, 6H, 8H	42, 43, 44
Stark	4S, 32S, 42S	43, 44
Taft-Pierce	2H	42
Unimatic	5C	43
Van Norman	5V, 50V	43, 45
Vernon	9B, LB	44, 45
Viking	9B	44
Wade	5C, 8WN	43, 44
Walcott	2H, 6H	42, 43
Western	Requires Sjogren Chuck	—
Whitcomb-Blaisdell	4C	43
Willard	3H	42
Worcester	2H, 3H	42

Collets by Style

Collet	Part Number	Figure	Dimensions			Rated Capacity		
			A	B	C	Round	Hexagon	Square
			Back Bearing	Overall Length	Thread			
1A	9-1501	1	.650" (16.51)	2.563" (65.10)	.640" x 26 RH	1/2" (12.70)	7/16" (11.11)	11/32" (8.73)
1AM	1505	1	1.125" (28.58)	3.906" (99.21)	1.118" x 24 RH	1" (25.40)	7/8" (22.23)	23/32" (18.26)
1B	9-1509	2	.437" (11.10)	1.750" (44.45)	.312" x 30 RH	5/16" (7.94)	7/32" (5.56)	3/16" (4.76)
1C	1511	1	.335" (8.51)	1.438" (36.53)	.322" x 40 RH	1/4" (6.35)	7/32" (5.56)	11/64" (4.37)
1J	1513	1	1.250" (31.75)	3.000" (76.20)	1.238" x 20 RH	1 1/16" (26.99)	7/8" (22.23)	3/4" (19.05)
1K	1521	3	1.250" (31.75)	2.813" (71.45)	—	1" (25.40)	7/8" (22.23)	23/32" (18.26)
2A	9-1527	1	.860" (21.84)	3.313" (84.15)	.850" x 20 RH	1 1/16" (17.46)	19/32" (15.08)	15/32" (11.91)
2AB	9-1529	2	.750" (19.05)	2.563" (65.10)	.500" x 20 RH	5/8" (15.88)	31/64" (12.30)	25/64" (9.92)
2AM	9-1531	1	.629" (15.98)	3.188" (80.98)	.622" x 24 RH	1/2" (12.70)	7/16" (11.11)	11/32" (8.73)
2B*	9-1533	2	.590" (14.99)	2.031" (51.59)	.437" x 26 RH	1/2" (12.70)	7/16" (11.11)	11/32" (8.73)
2C	9-1535	1	.450" (11.43)	1.812" (46.02)	.442" x 30 RH	1 1/32" (8.73)	19/64" (7.54)	15/64" (5.95)
2H	1537	1	.826" (20.98)	4.250" (107.95)	.799" x 20 RH	5/8" (15.88)	17/32" (13.50)	7/16" (11.11)
2J	1539	1	1.625" (41.28)	3.250" (82.55)	1.611" x 18 RH	1 3/8" (34.93)	1 3/16" (30.16)	1" (25.40)
2L	9-1553	1	.950" (24.13)	3.000" (76.20)	.938" x 20 RH	3/4" (19.05)	21/32" (16.67)	17/32" (13.50)
2M	1555	4	2 Morse 2 Morse	2.875" (73.03)	.375" x 16 RH	1/2" (12.70)	13/32" (10.31)	11/32" (8.73)
2NS	1693	1	.324" (8.23)	1.562" (39.67)	.318" x 40 RH	1/4" (6.35)	13/64" (5.16)	11/64" (4.37)
2OS	1691	1	.299" (7.59)	1.250" (31.75)	.263" x 40 RH	3/16" (4.76)	5/32" (3.97)	1/8" (3.18)
2S	1557	1	.750" (19.05)	3.234" (82.14)	.745" x 18 RH	9/16" (14.29)	31/64" (12.30)	25/64" (9.92)
2VB	9-1561	2	.595" (15.11)	2.438" (61.93)	.437" x 26 RH	1/2" (12.70)	7/16" (11.11)	11/32" (8.73)
3AM	9-1569	1	.750" (19.05)	3.188" (80.98)	.742" x 24 RH	5/8" (15.88)	17/32" (13.50)	7/16" (11.11)
3AT	1573	1	.687" (17.45)	2.313" (58.75)	.637" x 26 RH	1/2" (12.70)	7/16" (11.11)	11/32" (8.73)
3B	1581	2	.875" (22.23)	3.438" (87.33)	.625" x 16 RH	3/4" (19.05)	41/64" (16.27)	17/32" (13.50)
3C	1583	1	.650" (16.51)	2.688" (68.28)	.640" x 26 RH	1/2" (12.70)	7/16" (11.11)	11/32" (8.73)
3H	1589	1	1.125" (28.58)	4.438" (112.73)	1.050" x 20 RH	7/8" (22.23)	3/4" (19.05)	5/8" (15.88)
3JA	1593	1	2.000" (50.80)	3.750" (95.25)	1.988" x 20 RH	1 3/4" (44.45)	1 1/2" (38.10)	1 1/4" (31.75)
3NS	1601	1	.687" (17.45)	2.875" (73.03)	.647" x 20 RH	1/2" (12.70)	7/16" (11.11)	11/32" (8.73)

* Do not confuse with 2B Simmons - See Turret Lathe chapter in Automatics Catalog — #2287
 ^ Internal Stop Thread is 1.790 x 24 RH

NOTE: Millimeters in parentheses.
 Part numbers preceded by 9 are special order.

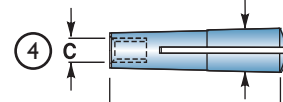
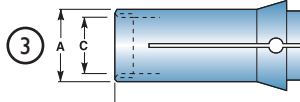
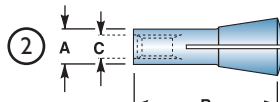
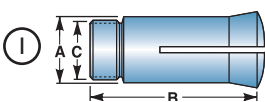

Collet	Part Number	Figure	Dimensions			Rated Capacity		
			A	B	C	Round	Hexagon	Square
			Back Bearing	Overall Length	Thread			
3OS	9-1603	1	.589" (14.96)	2.094" (53.19)	.518" x 26 RH	3/8" (9.53)	5/16" (7.94)	17/64" (6.75)
3PN	9-1605	1	.650" (16.51)	2.063" (52.40)	.645" x 24 RH	1/2" (12.70)	7/16" (11.11)	11/32" (8.73)
3PO	9-1607	1	.599" (15.21)	2.063" (52.40)	.500" x 24 RH	3/8" (9.53)	5/16" (7.94)	17/64" (6.75)
3S	9-1609	1	1.000" (25.40)	4.594" (116.69)	.995" x 20 RH	3/4" (19.05)	21/32" (16.67)	17/32" (13.50)
3SC	9-1613	1	.350" (8.89)	1.587" (40.30)	.293" x 36 RH	3/16" (4.76)	5/32" (3.97)	1/8" (3.18)
3SS	9-1611	1	.589" (14.96)	2.125" (53.98)	.515" x 26 RH	3/8" (9.53)	5/16" (7.94)	17/64" (6.75)
4C	1621	1	.950" (24.13)	3.000" (76.20)	.938" x 20 RH	3/4" (19.05)	21/32" (16.67)	17/32" (13.50)
4NS	1625	1	.826" (20.98)	3.500" (88.90)	.800" x 20 RH	5/8" (15.88)	17/32" (13.50)	7/16" (11.11)
4OS	9-1629	1	.750" (19.05)	2.781" (70.64)	.660" x 20 RH	1/2" (12.70)	7/16" (11.11)	11/32" (8.73)
4PN	9-1631	1	1.000" (25.40)	2.906" (73.81)	.995" x 16 RH	3/4" (19.05)	21/32" (16.67)	17/32" (13.50)
4S	9-1635	1	.998" (25.35)	3.250" (82.55)	.982" x 20 RH	3/4" (19.05)	21/32" (16.67)	17/32" (13.50)
5C ^A	1001	1	1.250" (31.75)	3.281" (83.34)	1.238" x 20 RH ¹	11/16" (26.99)	29/32" (23.02)	3/4" (19.05)
5M	9-1643	2	1.438" (36.53)	3.438" (87.33)	1.238" x 20 RH	7/8" (22.23)	3/4" (19.05)	5/8" (15.88)
5NS	9-1647	1	1.062" (26.97)	4.219" (107.16)	1.050" x 20 RH	7/8" (22.23)	3/4" (19.05)	5/8" (15.88)
5OS	H5026	1	1.062" (26.97)	3.500" (88.90)	.937" x 18 RH	3/4" (19.05)	41/64" (16.27)	33/64" (13.10)
5P	9-1651	1	.812" (20.62)	3.687" (93.65)	.807" x 24 RH	5/8" (15.88)	17/32" (13.50)	7/16" (11.11)
5PN	9-1653	1	1.312" (33.32)	3.406" (86.51)	1.307" x 16 RH	1" (25.40)	7/8" (22.23)	23/32" (18.26)
5SC	9-1655	1	.600" (15.24)	2.438" (61.93)	.500" x 26 RH	3/8" (9.53)	21/64" (8.33)	17/64" (6.75)
5ST	1017	1	1.250" (31.75)	3.281" (83.34)	1.238" x 20 RH	11/16" (26.99)	29/32" (23.02)	3/4" (19.05)
5V	9-1657	1	.850" (21.59)	3.875" (98.43)	.775" x 18 RH	9/16" (14.29)	31/64" (12.30)	25/64" (9.92)
6H	1667	1	1.375" (34.93)	4.750" (120.65)	1.300" x 20 RH	1 1/8" (28.58)	31/32" (24.61)	51/64" (20.24)
6K	1671	1	.842" (21.39)	3.000" (76.20)	.762" x 26 RH	5/8" (15.88)	17/32" (13.50)	7/16" (11.11)
6L	1675	1	1.250" (31.75)	4.438" (112.73)	1.178" x 20 RH	1" (25.40)	7/8" (22.23)	23/32" (18.26)
6NS	1663	1	1.312" (33.32)	5.906" (150.01)	1.234" x 14 RH	1" (25.40)	55/64" (21.83)	45/64" (17.86)
6R	1679	1	1.375" (34.93)	4.938" (125.43)	1.300" x 20 RH	1 1/8" (28.58)	31/32" (24.61)	25/32" (19.85)

A – Internal stop thread is 1.041" x 24 RH.

NOTE: Millimeters in parentheses.
Part numbers preceded by 9 or H are special order.

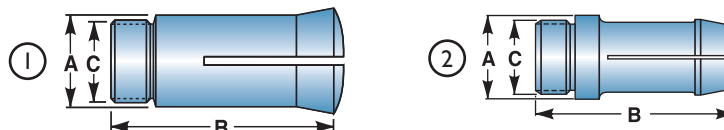

Collets by Style

Collet	Part Number	Figure	Dimensions			Rated Capacity		
			A	B	C	Round	Hexagon	Square
			Back Bearing	Overall Length	Thread			
7B	9-1685	2	7 B & S 7 B & S	3.125" (79.38)	.375" x 16 RH	1/2" (12.70)	13/32" (10.32)	11/32" (8.73)
7 B & S	9-1687	2	7 B & S 7 B & S	2.875" (73.03)	.375" x 16 RH	1/2" (12.70)	13/32" (10.32)	11/32" (8.73)
7P	9-1689	1	1.125" (28.58)	4.750" (120.65)	1.120" x 20 RH	7/8" (22.23)	3/4" (19.05)	5/8" (15.88)
7R	2581	3	1.062" (26.97)	3.500" (88.90)	—	7/8" (22.22)	3/4" (19.05)	5/8" (15.88)
8H	9-1695	1	1.500" (38.10)	4.750" (120.65)	1.425" x 20 RH	1 1/4" (31.75)	1 1/16" (26.99)	7/8" (22.23)
8ST	9-1697	1	2.375" (60.33)	5.906" (150.01)	2.354" x 12 RH	2 1/8" (53.98)	1 27/32" (46.83)	1 1/2" (38.10)
8WN	1699	1	1.250" (31.75)	3.875" (98.43)	1.245" x 16 RH	1" (25.40)	7/8" (22.23)	23/32" (18.26)
9B	9-1707	2	9 B & S 9 B & S	4.125" (104.78)	.500" x 13 RH	3/4" (19.05)	4 1/64" (16.27)	17/32" (13.50)
10L	9-1713	1	1.562" (39.67)	5.500" (139.70)	1.490" x 18 RH	1 1/4" (31.75)	1 1/16" (26.99)	7/8" (22.23)
10P	9-1715	1	1.500" (38.10)	4.750" (120.65)	1.495" x 20 RH	1 1/4" (31.75)	1 1/16" (26.99)	7/8" (22.23)
16C ^A	1717	1	1.889" (47.98)	4.312" (109.52)	1.870" x 1.75 mm RH ¹	1 5/8" (41.28)	1 13/32" (35.72)	1 9/64" (28.97)
20C ^B	1701		2.378" (60.40)	6.250" (158.75)	M60-1.5mm RH	2" (50.80)	1 3/4" (44.85)	1 27/64" (36.07)
20W	1777	1	.787" (19.99)	2.719" (69.06)	.775" X 6 thrds/cm RH Buttress	9/16" (14.29)	31/64" (12.30)	25/64" (9.92)
22J	1719	1	2.562" (65.07)	4.000" (101.60)	2.550" x 18 RH	2 1/4" (57.15)	1 15/16" (49.21)	1 9/16" (39.69)
25C ^C	1801	1	2.930" (74.42)	6.480" (161.49)	M73 x 1.5mm RH	2.559" (65.00)	2.216" (56.29)	1.808" (45.92)
25W	1901	5	.984" (24.99)	3.719" (94.46)	.970" x 15 RH Buttress	3/4" (19.05)	4 1/64" (16.27)	17/32" (13.49)
25W OS Thru1903 (Oversize)		4	.984" (24.99)	3.719" (94.46)	.970" x 15 RH Buttress	3/4" (19.05)	4 1/64" (16.27)	17/32" (13.49)
25W OS Stepped	1903	4	.984" (24.99)	3.719" (94.46)	.970" x 15 RH Buttress	.751" - 1" (19.07 - 25.40)	.642" - 7/8" (16.30 - 22.22)	.532" - 3/4" (13.51 - 19.05)
32S	1723	1	.703" (17.86)	2.563" (65.10)	.690" x 24 RH	1/2" (12.70)	7/16" (11.11)	11/32" (8.73)
35J	9-1727	1	3.875" (98.43)	5.000" (127.00)	3.861" x 18 RH	3 1/2" (88.90)	3" (76.20)	2 7/16" (61.91)
42S	9-1729	1	1.250" (31.75)	3.688" (93.68)	1.236" x 20 RH	1" (25.40)	7/8" (22.23)	23/32" (18.26)

A - Internal stop thread is 1.687" x 20 RH.
 B - Internal stop thread is M53 x 1mm RH.
 C - Internal stop thread is 2 5/8" - 24 TPI RH.

NOTE: Millimeters in parentheses.
 Part numbers preceeded by 9 are special order.

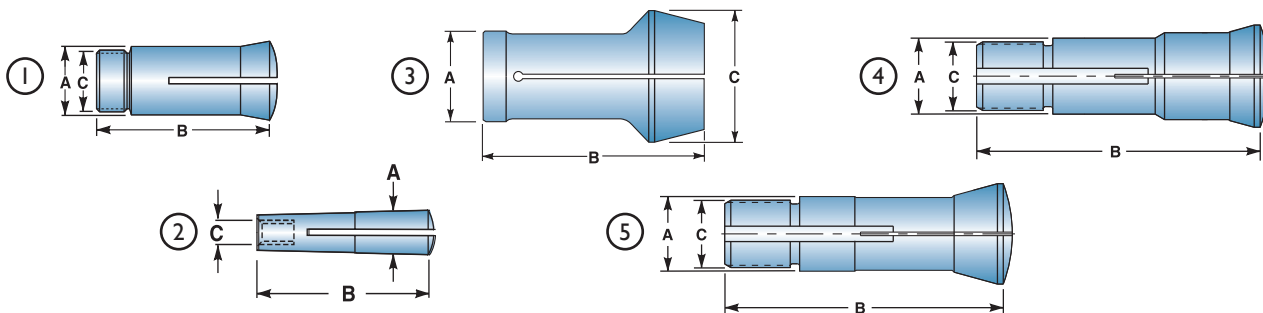

Collet	Part Number	Figure	Dimensions			Rated Capacity		
			A	B	C	Round	Hexagon	Square
			Back Bearing	Overall Length	Thread			
50V	1731	6	1.250" (31.75)	4.000" (101.60)	1.125" x 24 RH	¹⁵ / ₁₆ " (23.81)	¹³ / ₁₆ " (20.64)	²¹ / ₃₂ " (16.67)
52SC	9-1733	1	.800" (20.32)	3.688" (93.68)	.795" x 20 RH	⁵ / ₈ " (15.88)	¹⁷ / ₃₂ " (13.50)	⁷ / ₁₆ " (11.11)
115	1735	1	1.344" (34.14)	3.500" (88.90)	1.307" x 20 LH	1 ¹ / ₈ " (28.58)	³¹ / ₃₂ " (24.61)	⁵¹ / ₆₄ " (20.24)
215	9-1739	1	2.030" (51.56)	4.750" (120.65)	1.990" x 18 LH	1 ³ / ₄ " (44.45)	1 ¹ / ₂ " (38.10)	1 ⁷ / ₃₂ " (30.96)
315	1743	1	3.687" (93.65)	5.500" (139.70)	3.622" x 16 LH	3 ¹ / ₄ " (82.55)	2 ¹³ / ₁₆ " (71.44)	2 ¹ / ₄ " (57.15)
B3	1745	5	.650" (16.51)	3.031" (76.99)	.437" x 20 RH	¹ / ₂ " (12.70)	⁷ / ₁₆ " (11.11)	1 ¹ / ₃₂ " (8.73)
B32 Thru-Hole	2249	1	1.259" (31.97)	4.008" (101.80)	Buttress 1.169" x 15 RH	.943" (23.95)	.817" (20.75)	.667" (16.94)
B32 Stepped	2249	1	1.259" (31.97)	4.008" (101.80)	Buttress 1.169" x 15 RH	.943" to 1.25" (23.95 to 3.17)	.817" to 1.091" (20.75 to 17.71)	.667" to .89" (16.94 to 22.6)
B32/45 Thru-Hole	2239	4 (page 44)	1.259" (31.97)	4.623" (117.42)	Buttress 1.169" x 15 RH	⁵⁹ / ₆₄ " (23.41)	.817" (20.75)	.667" (16.94)
B32/45 Stepped	2241	4 (page 44)	1.259" (31.97)	4.623" (117.42)	Buttress 1.169" x 15 RH	.922" to 1 ³ / ₄ " (23.4 to 44.45)	.817" to 1 ¹ / ₂ " (20.75 to 38.10)	.667" to 1 ¹ / ₄ " (16.94 to 31.7)
B45 Thru-Hole	2243	1	1.771" (44.98)	4.290" (108.96)	M42 x 1.5 RH	1 ¹³ / ₃₂ " (35.71)	1.240" (31.49)	1.013" (25.73)
B45 Stepped	2245	1	1.771" (44.98)	4.290" (108.96)	M42 x 1.5 RH	1.407" to 1 ³ / ₄ " (35.73 to 44.45)	1.240" to 1 ¹ / ₂ " (31.49 to 38.10)	1.013" to 1.25" (25.73 to 31.7)
D5	9-1747	5	.780" (19.81)	3.031" (76.99)	.500" x 20 RH	⁵ / ₈ " (15.88)	¹⁷ / ₃₂ " (13.50)	⁷ / ₁₆ " (11.11)
GTM	1789	5	.625" (15.88)	2.437" (61.90)	.437" x 20 RH	¹ / ₂ " (12.70)	⁷ / ₁₆ " (11.11)	1 ¹ / ₃₂ " (8.73)
J & L Center Mill MP2932	7	7	.999" (25.37)	4.375" (111.13)	.625" x 11 RH	³ / ₄ " (19.05)	⁴¹ / ₆₄ " (16.27)	³³ / ₆₄ " (13.10)
JC	1751	6	1.360" (34.54)	4.000" (101.60)	—	1 ³ / ₁₆ " (30.16)	1" (25.40)	1 ³ / ₁₆ " (20.64)
LB	1755	2	.687" (17.45)	2.000" (50.80)	—	¹ / ₂ " (12.70)	⁷ / ₁₆ " (11.11)	1 ¹ / ₃₂ " (8.73)
Pro 20 Thru-Hole	2247	4 (page 44)	.7874" (20)	3.700" (93.98)	Buttress .775" x 6 Thrds/cm	.5708" (14.50)	.4921" (12.5)	.3937" (10.0)
Pro 20 Stepped	2247	4 (page 44)	.7874" (20)	3.700" (93.98)	Buttress .775" x 6 Thrds/cm	.5708" to .7874" (14.50 to 20.0)	.4921" to .6693" (12.5 to 17.0)	.3937" to .551" (10.0 to 14.0)
RO	9-1769	3	1.250" (31.75)	2.938" (74.63)	.875" x 16 RH	1 ¹ / ₈ " (28.58)	³¹ / ₃₂ " (24.61)	²⁵ / ₃₂ " (19.85)
RO	9-1771	4	1.250" (31.75)	4.437" (112.70)	.875" x 16 RH	.800" (20.32)	1 ¹ / ₁₆ " (17.46)	⁹ / ₁₆ " (14.29)
RO	9-1773	4	1.250" (31.75)	4.437" (112.70)	.875" x 16 RH	1 ¹ / ₈ " (28.58)	³¹ / ₃₂ " (24.61)	²⁵ / ₃₂ " (19.85)
RO	9-1767	3	1.250" (31.75)	2.938" (74.63)	.875" x 16 RH	.800" (20.32)	1 ¹ / ₁₆ " (17.46)	⁹ / ₁₆ " (14.29)
R8	1757	5	.950" (24.13)	4.000" (101.60)	.437" x 20 RH	³ / ₄ " (19.05)	⁴¹ / ₆₄ " (16.27)	1 ⁷ / ₃₂ " (13.50)

NOTE: Millimeters in parentheses.
Part numbers preceded by 9 or MP are special order.

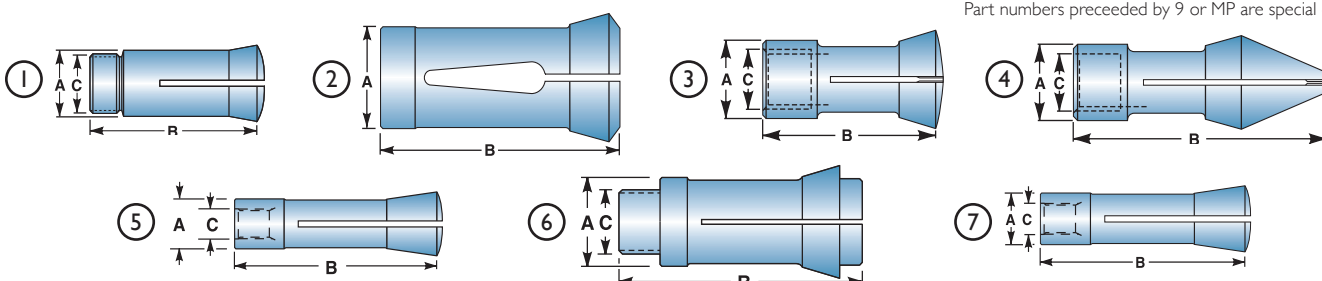

Frequently Asked Questions

Why buy a Hardened, Precision-Machined Collet?

A hardened, precision-machined collet has a head angle and bore that are case hardened to 60 to 63 Rockwell. This will give you the maximum life possible. The bore is hardened, precision-machined and guaranteed to have a TIR of .001" or less. Special-accuracy collets are available that are guaranteed to have a TIR of .0002". Before investing in a special-accuracy collet, check your standard collet – they usually have a TIR of .0005" or better.

Why not buy a bargain collet?

A bargain is possible because something has been compromised. The head angle and bore are not in the 60+ Rockwell range. The back bearing of the collet is not held to precision size and concentricity tolerances. The bore, head angle, back bearing and thread are not all concentric with each other. Because the collet is softer than a Hardinge collet, it will wear very quickly. A hardened, precision-machined collet can last for years.

When should I use an emergency collet?

An emergency collet can be used when:

- You need a collet bore to run as close as the spindle's TIR; an emergency is bored in place in the machine's spindle.
- A hardened, precision-machined collet is necessary for any long run or high wear situation. But, if one doesn't exist in your inventory, an emergency collet can be quickly bored to size. It allows the job to get in the schedule while waiting for delivery of the hardened, precision-machined collet.
- A job consisting of a couple hundred parts and the proper size hardened, precision-machined collet is not available.

Points to consider: The head angle and the collet bore are not heat treated on emergency collets and will wear quickly under heavy or long use. The rule of thumb for the life of the bore and leaf tension of an emergency collet is 300 to 500 pieces. The threads are heat treated but the leaves of the collet are not spring tempered. This results in the collet leaves losing their elasticity. Eventually you will not be able to put the part in the collet because the leaves have lost their tension.

Why do I have to use a stop plate with my Sure-Grip Expanding Collet?

The expanding collet is pulled back with a draw plug to open it. If the chucking ID of the parts vary, the collet will pull back or stick out farther than the previous piece. The Stop Plate eliminates the movement of the part and also stabilizes it for heavy stock removal.

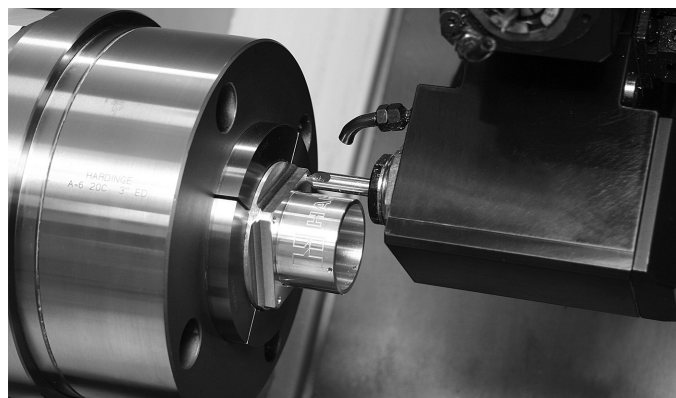

Is there an adapter that allows me to use my 5C collets in the I6C spindle?

Yes, there is a I6C-to-5C collet adapter which accepts 5C collets. There are many limitations, however. The major one is concentricity. Because of the number of parts in the assembly, the TIR will be .002" or more. If you are a production shop, you should not consider the adapter except for emergency situations. It takes about 15 minutes to change a collet. When doing secondary work, it will not be possible to hold concentricity of less than .002". Adapters are also available for 20C-to-I6C and 25C-to-I6C.

Why do I need Dead-Length® Collets or Step Chucks?

All draw-in collets have a diameter-to-length ratio when doing secondary operations. When using 5C, I6C, 20C, 25C collets or other collets with a 10° head angle, the ratio is 1:3. For every .001" change on the chucking diameter, the part will either pull back .003" or stick out .003" from the setup part. This can mean a total length variation of .009" when the chucking diameter varies .003". If the print calls for a length tolerance less than .002", a standard collet cannot be used. This is where the Dead-Length collet is ideal. If the stock diameter varies .003", the finished part lengths will not vary more than a few ten thousandths of an inch (.0002" to .0005").

I have noticed that the threads and back bearing on our collets are being damaged and have to be replaced. How can I eliminate this expense?

Vises, vise-grips and pump pliers are probably the cause of your problem. Purchase several collet wrenches for each style (5C, I6C, 20C, 25C, etc.) collet in your shop. These wrenches are keyed and locate over the back bearing of the collet to hold it while the threaded stop, Dead-Length assembly, etc., are tightened into the collet.

I have Style "S" Master Collets on my multi-spindle automatics. Can I use them on my CNC Lathe?

Possibly. If you're doing bar work, they work very well. The Style "S" Master Collet system was developed for use on multi-spindle automatic bar machines where collet runout is of very little concern. Secondary work on CNC machines requires very good collet concentricity, usually better than .001" TIR. Style "S" Master Collet system's TIR could be as high as .004" to .008", making them unacceptable for secondary work. Emergency pads will work in an emergency. Once you remove them, they cannot be used to run the same job again as their TIR will be unacceptable.

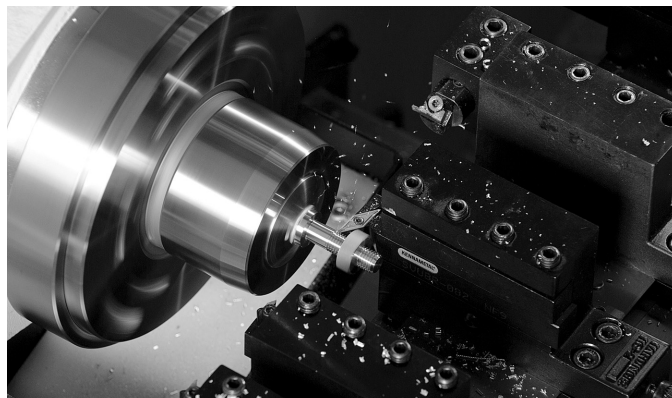

What is the difference between the Dead-Length® Collet and the Dead-Length Spider-Stop Step Chucks?

The Dead-Length Collet uses the face of the spindle as its locating surface for the inner collet. Because the spindle doesn't move when the draw bar pulls the collet back, the inner collet also doesn't move, resulting in length control. The Dead-Length Spider-Stop Step Chuck uses a spider stop that fits inside the slots of the step chuck and locates against the collet seat (angle) of the spindle. Because the collet seat doesn't move when the draw bar pulls back the step chuck, neither does the spider stop or the workpiece. There is an internal thread in the face of the spider which accepts the male thread in the stop button. The customer has to bore out the step chuck to accommodate the stop button. The stop button is machined to conform to the location point of the workpiece.

Is there ever a reason I would use a Dead-Length Spider-Stop Step Chuck for small diameter work?

Yes. Occasionally a customer finds that the standard 5C Dead-Length Collet does not allow them to hold their parts to the print's concentricity requirements. A Dead-Length collet does not run as concentric as a Hardened, Precision-Machined collet even though it may be bored in place. This is because of the allowances between the moving parts. A Dead-Length Spider Step Chuck is identical to a standard collet; there is only one moving part — the step chuck. This attribute will allow closer concentricities between chucking and machined diameters than with a standard Dead-Length collet.

I have a 6" diameter part which I want to hold in a Dead-Length Spider-Stop Step Chuck, but it has a maximum size of 4". What can I do?

Order a special Dead-Length step chuck. Request Hardinge Brochure #2285, "Precision Length Control", which describes many ways to control length and various ideas relating to step chucks.

Will threaded collet stops help me hold lengths?

No, however if the diameter of the part being gripped is held to a very close tolerance, the answer could be yes. Unfortunately the stop is attached to the collet, which draws back with the draw bar. For every .001" variation in the chucking diameter, the collet will draw back or stick out .003". The main purpose of a collet stop is to eliminate the push-back of the part while it is being machined, or to automatically eject the part when the collet is opened.

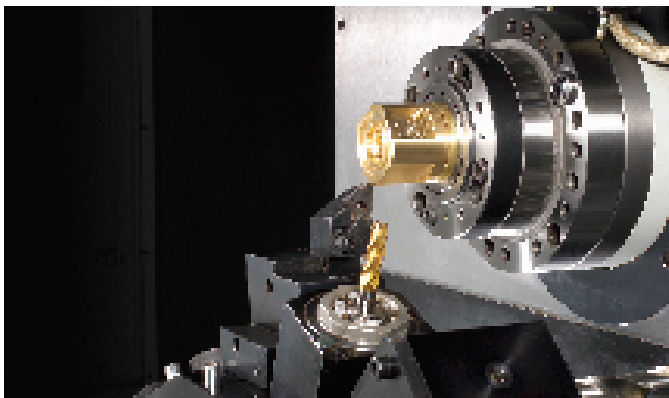

I have a part that requires internal gripping. After turning, I want to take it to a mill for additional work but still want to grip on the ID. What are my options?

There are two options – The "Master Expanding Collet" and the "Sure-Grip® Collet-Style Expanding Collet." Both of these can be taken to an index fixture or dividing head that has a 5C or 16C collet seat. The Master Expanding Collet uses interchangeable pads which can be removed and stored. This unit is opened with a draw plug that actuates the collet in the front. It is mainly for light-duty machining. The Sure-Grip Collet-Style Expanding Collet system will also work. The collets are parallel opening and have a range from .125" to 4". This system, in the larger sizes, can handle heavy-duty machining operations.

What is the correct procedure for boring out an emergency collet or step chuck?

Insert the collet in the spindle with the draw bar in the full open position. Make certain that all the pins are in the face of the collet or step chuck. Adjust the collet closer until closed on the pins and then back off $\frac{1}{8}$ to $\frac{1}{4}$ of a turn. DO NOT back off enough to where the collet angle is not fully seated in the spindle. Lock the draw bar in this position. Decrease the chucking force as much as possible (do not use the same force you would to grip the part). Close the collet. If you can pull the pins out, you should increase the chucking pressure until the pins cannot be removed. Rough and finish the bore to the chucking diameter of the part. Remove the collet or step chuck and deburr it. Thoroughly clean the spindle, step chuck, closer and then remount them. Adjust the collet closer for proper gripping and the correct draw bar pressure to hold the workpiece.

I have a part with a 9" chucking diameter to be run on my QUEST® T51 Lathe. I want to hold it in a step chuck which will allow me to run at my machine's maximum rpm. Your catalog lists the largest step chuck as 8". Can I get a larger step chuck and closer?

Yes. We have a full department set up to make special spindle tooling to help you with any situation you may encounter. You are right about using a step chuck and closer. If your part has a good chucking diameter (+.001", -.003"), you will be more productive than when holding the part in a 3-jaw power chuck. As with the jaw chuck, it is necessary to check for turret tooling interferences.



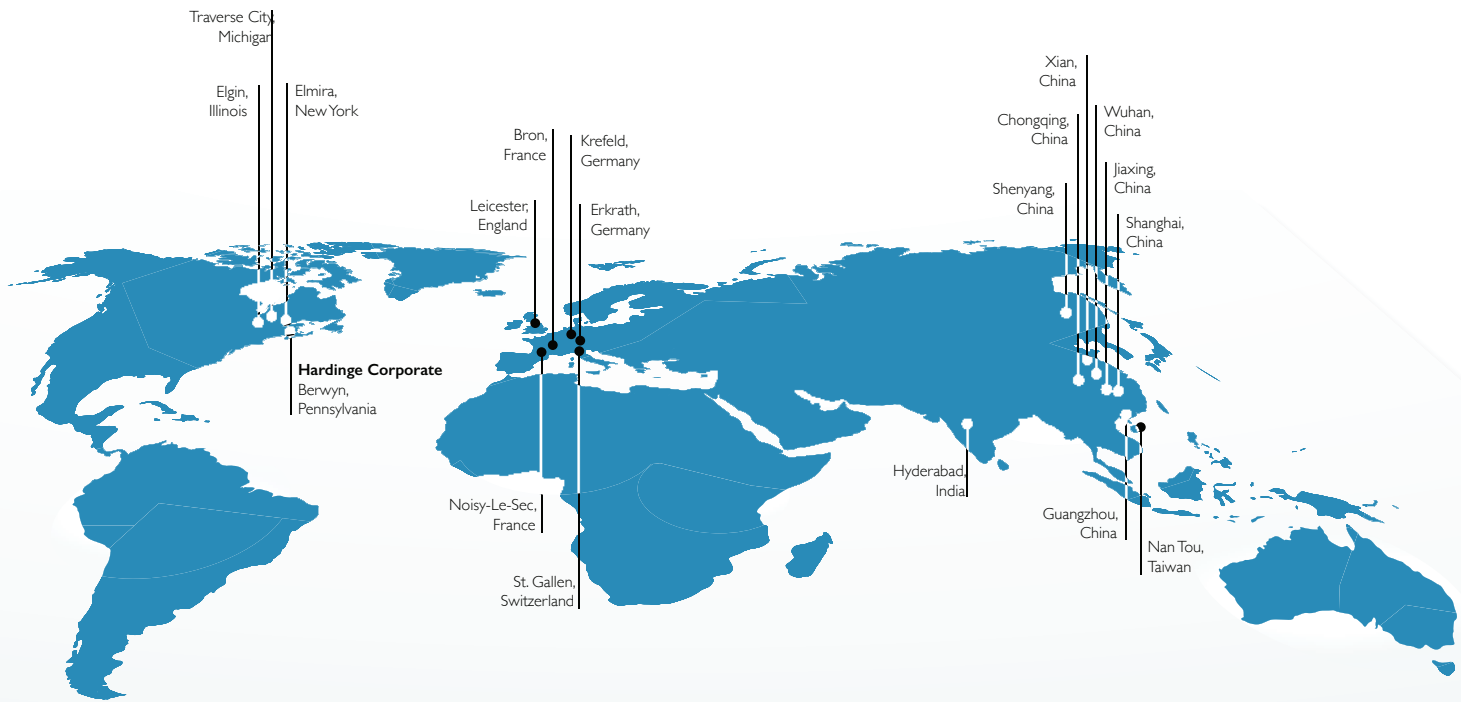

HARDINGE COMPANIES WORLDWIDE

Hardinge is a leading international provider of advanced metal-cutting solutions. We provide a full spectrum of highly reliable CNC turning, milling, and grinding machines as well as technologically advanced workholding accessories.

The diverse products we offer enable us to support a variety of market applications in industries including aerospace, agricultural, automotive, construction, consumer products, defense, energy, medical, technology, transportation and more.

We've developed a strong global presence with manufacturing operations in North America, Europe, and Asia. Hardinge applies its engineering and applications expertise to provide your company with the right machine tool solution and support every time.

AMERICAS

Hardinge Corporate
1235 Westlakes Drive
Suite 410
Berwyn, PA 19312

Hardinge
One Hardinge Drive
Elmira, NY 14903
P. 800-843-8801
E. info@hardinge.com
www.hardinge.com

Hardinge
1524 Davis Road
Elgin, IL 60123
P. 800.843.880

ASIA

China
Hardinge Machine
(Shanghai) Co. Ltd.
1388 East Kangqiao Road
Pudong, Shanghai 201319
P. 0086 21 3810 8686

Taiwan
Hardinge Taiwan Precision Machinery Limited
4Tzu Chiang 3rd Road
Nan Tou City 540
Taiwan
P. 886 49 2260 536
E. cs@hardinge.com.tw

EUROPE

Germany
Hardinge GmbH
Fichtenhain A 13c
47807 Krefeld
P. 49 2151 49649 10
E. info@hardinge-gmbh.de

Switzerland
L. Kellenberger & Co. AG
Heiligkreuzstrasse 28
CH 9008 St. Gallen
Switzerland
P. 41 71 2429111
E. info@kellenberger.net

All specifications subject to change without notice.
All marks indicated by ® and ™ are trademarks of their respective owners. #2348J • Litho in USA
© Hardinge Inc. 2018 • May 2018



Hyfore Workholding Limited
Units 2 & 3, 67 Blackhorse Road,
Longford, Coventry, CV6 6DP

Tel: 024 7699 3153 | Email: sales@hyfore.com
hyfore.com | hyfore.shop